



RADIO'S LIVEST MAGAZINE

Broadcast
Number

Radio-Craft

February

25 Cents

in United States
and Canada

HUGO GERNSBACK Editor

**MODERN
STUDIO TECHNIQUE**
See Page 460



**Milestones in Broadcasting — Making a High-Fidelity Broadcast Receiver
How to Make a "Free Reference Point" Analyzer—War-Time Uses of Radio**

Your

KEY TO SERVICE Success in 1936

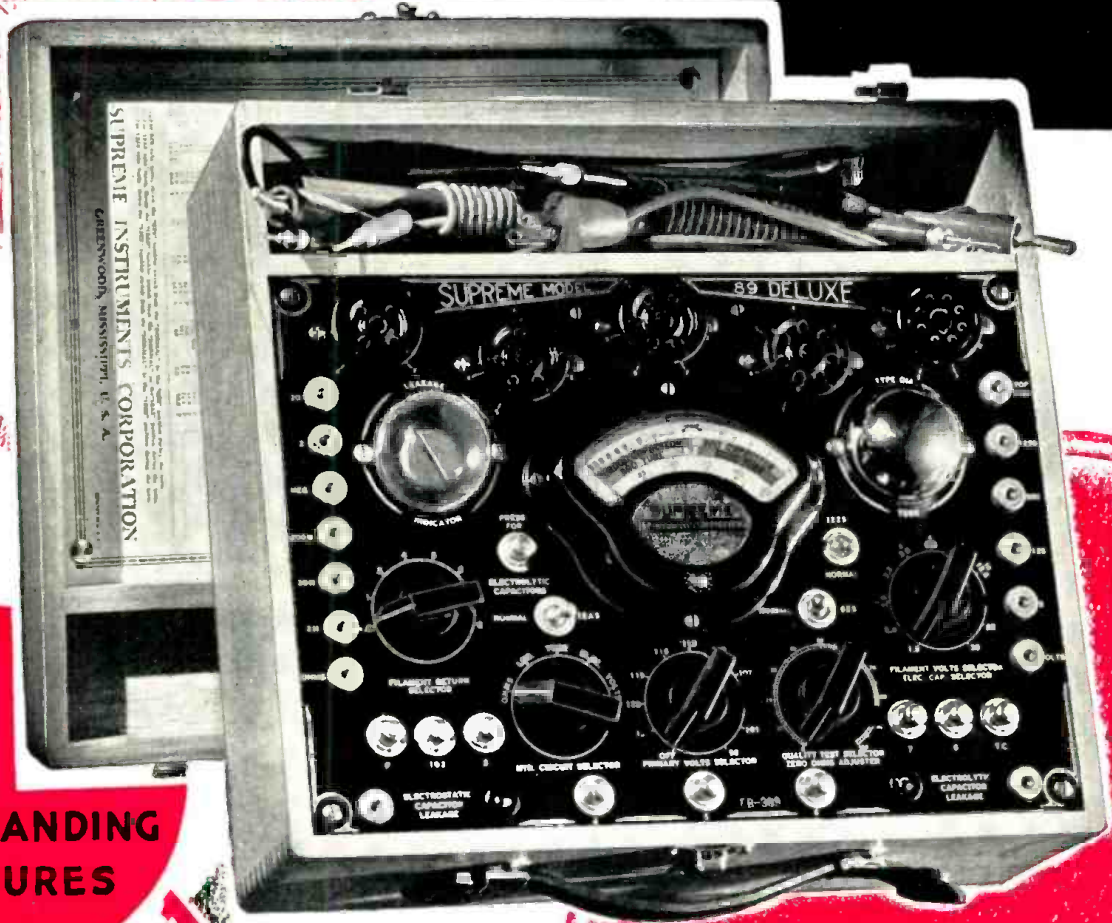

22

OUTSTANDING
FEATURES

7 INSTRUMENTS IN 1

SUPREME \$45.95 • 89 DELUXE • TUBE TESTER

Dealer Net Cash
Wholesale Price

Mr. Serviceman, 1936 is your big year of opportunity. More public purchasing power than at any time in the last six years. A Presidential election, over millions of additional listening hours will be added to the wear and tear of tubes. Your service equipment must keep as up-to-date as the newest radio sets and tubes.

In 1935 the Radio Service Industry had reason again to appreciate the advanced engineering design of Supreme Instruments. 1936 designs were inbuilt with facilities for all the metal tubes, and available with the same suddenness as the announcement of this great revolution in radio design. Supreme 89 DeLuxe speaks for itself—and as a result jobbers are recommending it as the No. 1 utility instrument. 22 outstanding features, 7 instruments in 1. Send for your free copy of "Evolution of Tube Testing" which gives you word detail and illustrated diagrams of this master service tool, which can be for you in 1936, what it has been to thousands of your colleagues in 1935, THE KEY TO SERVICE SUCCESS. See your jobber.



THE *Inside* STORY
DIAGRAMMED

Supreme Instruments Corp., Greenwood, Miss., U.S.A.

Export Dept., Associated Exporters Co., 145 West 45th St., New York City, N. Y. Cable Address, LOPREH, N. Y.

By Doing Actual Jobs — No Correspondence — On Modern Radio Equipment



View of Students operating our Television Camera and Scanning Unit

**TRAIN
in 12 Weeks
in the big
Chicago Shops
of Coyne**



Students operating our modern Transmitter

TELEVISION

**FOR
RADIO**

TALKING PICTURES

**No Advanced Education or Previous Experience Needed
to Master Thorough, Practical Coyne Training**

"Learn by Doing" methods train you to master RADIO—NOT A CORRESPONDENCE COURSE—NO BOOK STUDY—YOU DON'T HAVE TO RECITE LESSONS IN A CLASSROOM—you DON'T NEED advanced education or previous Radio Experience—START ANYTIME. You are trained right in modern, daylight shops on Radio, Sound and Television equipment under the personal supervision of expert instructors on the sort of work you will meet out in the field on a real job. That's why Coyne Practical Training is able to prepare you in such a short time. SPEND ONLY 12 WEEKS DOING ACTUAL WORK AT COYNE, and you should be ready to qualify for a big pay job. Do radio wiring and testing, trouble shooting, repairing and servicing. Work on a wide variety of modern, up-to-date A. C. Superheterodyne sets, oscillators, analyzers and test instruments. Learn how to operate television receiving and transmitting equipment; to install, test and service public address systems and sound picture equipment. Prepare for Amateur, Broadcast, or Telegraph Radio Operator's License and to know all code and Dept. of Commerce rules for a government License Examination.

Amazing Offer!

**PAY FOR YOUR TRAINING AFTER YOU GRADUATE
in Small Monthly Payments!**

Don't let financial embarrassment hold you back . . . If you are short of money we'll send you details of an amazingly easy finance plan and consider your application. If accepted, you won't have to start paying tuition back until five months from the date you start school or 60 days after your required training period . . . and then you'll

have 18 months to complete your payments. This plan has enabled hundreds of ambitious fellows to get Coyne Training with very little money. It can do the same for you. Many of our graduates have found their extra earnings more than enough to cover the small monthly payments.

**Earn Living Expenses
While You Are
Training!**

If you need part-time work to help pay your living expenses while training, write and tell us your problems and we may be able to help you. The Free Service of our Employment Department has enabled hundreds of deserving students to get part time jobs and earn part or all of their room and board while training in the great Coyne Chicago Shops.



**DIESEL ELECTRIC REFRIGERATION
AND AIR CONDITIONING**

Included Without Extra Cost

The fastest growing industries in America today. Manufacturers and Distributors of Diesel, Refrigeration and Air Conditioning equipment need Trained men who have Specialized in these rapidly expanding fields. Here at Coyne you will prepare to fill a job as installation and Service Man, Shop Mechanic, Tester, Assembler, Inspector, etc. You will learn about various types of compressors, condensers, temperature control devices, thermostatic and expansion valves—you will do actual electrical work on latest types of Diesel, Refrigerating and Air Conditioning machines. And, it won't cost you one extra cent to get this remarkable Training. We include it without charge with your regular Radio Training.



Home of Coyne Shops

This is our fireproof modern building wherein is installed thousands of dollars worth of Radio equipment of all kinds. Every comfort and convenience has been arranged to make you happy and contented during your Training.

**You Get Employment
Service After You
Graduate**

Our Graduate Employment Service will give you real employment help. As one of our graduates you will get assistance quickly, and every help we can give you to locate a job for which you have been Trained.

Mail The Coupon

Get the new "Coyne Opportunity Book" giving all facts about Coyne Training. Photographs of Shops showing students at work on modern Radio equipment under the personal supervision of Coyne Expert Instructors. Also details of our Spare Time Employment Service, Pay After Graduation Plan and Graduate Employment Service. Yours without cost. Simply mail the coupon.

**H. C. Lewis, President
Coyne Radio & Electrical School, Dept. 26-8H
500 S. Paulina St., Chicago, Ill.**

Send me your Big Free Book about Coyne Training and give me all details regarding your Spare Time Employment Service and Pay After Graduation Plan of easy, monthly payments.

NAME.....AGE.....
ADDRESS.....
CITY.....STATE.....

COYNE H. C. LEWIS, PRESIDENT FOUNDED 1899
RADIO & ELECTRICAL SCHOOL
500 S. Paulina St., Dept. 26-8H, Chicago, Ill.

Please Say That You Saw It in RADIO-CRAFT



CONTENTS—FEB., 1936, ISSUE

Volume VII

Number 8

Editorial: Needed Broadcast Reforms.....Hugo Gernsback	453
The Radio Month In Review.....	454
Milestones in Broadcasting.....W. E. Schrage	456
Radio Pictorial.....	458
Modern Studio Technique.....C. W. Palmer	460
Making a 12-Tube High-Fidelity Broadcast Receiver Part I.....M. H. Gernsback	461
How to Make a "Free-Reference-Point" Set Analyzer.....W. C. Bellheimer	462
2 New Metal Tubes.....F. M. Purinton	463
Testing Metal-Tube Sets with Present EquipmentF. L. Sprayberry	463
Make this "Radio" Motor.....Nathan I. Hall	464
A Novel, Self-Matching Output TransformerC. E. DeHorn	464
Readers' Department.....	465
International Radio Review.....	466
War-Time Uses of Radio.....E. W. Slope	467
The Renode—A New Gridless TubeSvend Anker-Rasmussen	468
New Developments in All-Wave Receiver Design.....	469
New German Television ReceiversManfred von Ardonne	470

HUGO GERNSBACK, Editor-in-Chief
C. W. PALMER Associate Editor
H. G. McENTEE Associate Editor
R. D. WASHBURNE, Technical Editor

Outstanding Merits of Metal TubesHerbert M. Neustadt	470
Operating Notes.....	471
A \$30,000 "Radio" Installation.....Russell D. Lanning	472
The Listening Post for All-Wave DX-ersCharles A. Morrison	473
Oscilloscope Servicing of All-Wave Sets.....E. E. Sayre	474
New Metal-Tube Chassis Simplifies "Modernizing" Old Sets.....Tobe Deutschmann	474
Servicing Theatre Sound Systems—Part III.....A. V. Ditty	475
Short-Cuts in Radio.....	476
A Beginner's A.C.-D.C. Super. "2".....R. D. Washburne	477
The Latest Radio Equipment.....	478
ORSMA Members' Forum.....	480
A School-Type Broadcast Studio.....	481
A Broadcast P.A. Unit for MusiciansCharles R. Shaw	481
RADIO SERVICE DATA SHEETS:	
No. 155—General Electric Models A82 and A87 8-Metal Tube All-Wave A.C. Superhets.....	482
No. 156—Stromberg-Carlson Model 62 and 63 8-Tube High-Fidelity Chassis; RCA Model 103 4- Tube A.C. Compact Superheterodyne.....	484
Technicians' Data Service.....	485
Book Review.....	503

(ANNUAL) BEGINNERS' NUMBER

Radio has so many subdivisions that the "beginner in radio" may be more nearly described as a beginner specializing in public address, electronics, short waves, auto radio, television, servicing, etc. For this reason the forthcoming specialized issue of RADIO-CRAFT devoted mainly to the beginner in radio will contain not only information concerning radio receivers but also valuable articles on many related subjects. All of these articles will be pre-

pared in easily understandable form so that the average person will be able to learn "what it's all about" without acquiring indigestion over a lot of heavy technical explanations. Expert technicians have prepared easily understandable articles on all the topics mentioned above. Also, the radio set builder has not been forgotten—easily-built radio devices are described in detail for his benefit.

Don't miss the special RADIO BEGINNERS' NUMBER of Radio-Craft, on the newsstands January 1.

HUGO GERNSBACK, President I. S. MANHEIMER, Secretary
Published by Continental Publications, Inc. Publication office: 404 N. Wesley Ave., Mount Morris, Illinois. Editorial and Advertising Office: 99 Hudson Street, New York City. Chicago Advertising Office: L. F. McClure, 919 North Michigan Avenue, Chicago, Ill. Western Advertising Office: Loyd B. Chappel, 511 So. Alexandria St., Los Angeles, Calif.

European Agents:

London—Gorrings's American News Agency, 9A Green St., Leicester Square, London, W. C. 2.
Paris—Messageries Dawson, 4 Rue Faubourg, Poissonniere, Paris, France.
Australian Agent: McGill's Agency, 179 Elizabeth St., Melbourne.

RADIO-CRAFT is published monthly, on the first of the month preceding that of date; its subscription price is \$2.50 per year. (In Canada and foreign countries, \$3.00 a year to cover additional postage.) Entered at the post office at Mount Morris, Ill., as second-class matter under the act of March 3, 1879.

Text and illustrations of this magazine are copyright and must not be reproduced without permission of the copyright owners. We are also agents for WONDER STORIES and EVERYDAY SCIENCE AND MECHANICS. Subscription to these magazines may be taken in combination with RADIO-CRAFT at reduced Club rates. Write for information.

Copyright 1936. Continental Publications, Inc.

YES! I'll send you a FREE LESSON
 on Radio Servicing Tips
 to PROVE that it's Practical
 to Learn at Home to Make
GOOD MONEY IN RADIO



MANY RADIO EXPERTS MAKE \$30 \$50 \$75 A WEEK

Mail Coupon Today! I'm so sure I can train you at home in spare time that I'll send a FREE LESSON to prove how easy it is to become a RADIO EXPERT.

Get ready NOW for jobs paying \$30 \$50 \$75 a week. Train for a job with a RADIO MANUFACTURER, DEALER OR JOBBER, or to go into a BUSINESS OF YOUR OWN. Get facts about the opportunities in Radio, Television, Loud Speaker Systems, Short Wave Radio.

I will also send you my FREE 64-PAGE BOOK- "Rich Rewards in Radio"- telling about my training and the opportunities for which it fits you; how I give you Practical Experience with Radio Equipment I supply, as well as Book Training; how I give you Extra Money Job Sheets to help you make \$5 \$10 \$15 Extra in your spare time while learning. My book ALSO contains many letters from graduates telling what they are doing and learning- Get the facts about my MONEY BACK AGREEMENT and many other N.R.I. features.

Why put up any longer with a low pay, no-future job. Train for Radio at home in spare time. Get the facts now. Mail Coupon for my FREE BOOK and FREE SAMPLE LESSON.

J.E. Smith

NATIONAL RADIO INSTITUTE

Washington, D. C.

MAIL THIS COUPON FOR FACTS

J.E. SMITH President
 NATIONAL RADIO INSTITUTE
 DEPT. 6BX, WASHINGTON, D. C.
 PLEASE SEND ME WITHOUT OBLIGATION YOUR
 FREE BOOK "Rich Rewards in Radio"
 AND FREE LESSON ON SERVICING TIPS.

NAME -----
 ADDRESS -----
 CITY----- STATE -----
 14X-1

Announcing Pre-Publication Offer of

Official Radio Service Handibook

by J. T. Bernsley

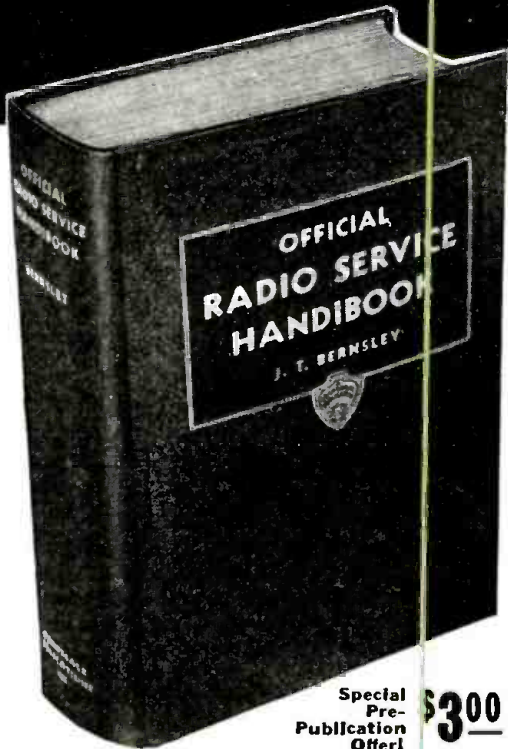

Special Pre-Publication Offer! **\$3.00**

OVER 1,000 PAGES

Over 750 Illustrations

6X9 inches

Beautiful Leatheroid Cover

OVER 250 PAGES OF OPERATING NOTES

Whether It is a fading job, lack of sensitivity, noise within the receiver, aligning a chassis, poor A.V.C. action or any other trouble that is usually the "bugaboo" of most Service Men, you will find the symptoms and remedy clearly described in **OFFICIAL RADIO SERVICE HANDBOOK**. The exact procedure for repairing, as well as the characteristic trouble in almost all models of manufactured sets, will be found in the section on **OPERATING NOTES**—over 250 pages of this data, the most important information to any radio man in the servicing field. The material in this section has been arranged, as well as classified, so there is no difficulty in immediately locating the necessary information.

HERE'S the sensational new book on radio servicing that contains *everything* Service Men must know. The book, **OFFICIAL RADIO SERVICE HANDBOOK**, is edited by J. T. Bernsley, foremost radio service authority. This 1936 service guide is the *only book of its kind*—its editorial material is so well prepared that the technical information can be understood by even beginners in radio servicing. Every page contains new material, new illustrations—no reprinted literature or rehashed articles.

Over a thousand actively engaged Service Men have helped prepare the service data found in the **OFFICIAL RADIO SERVICE HANDBOOK**. Their contributions, in the form of service notes, short cuts, and trade secrets make this book the outstanding volume on radio servicing ever to be published.

The **OFFICIAL RADIO SERVICE HANDBOOK** covers thoroughly over 500 radio topics. It tells you how to analyze the latest commercial receiver circuits; how to really make money servicing midget sets; and, how aligning supers can be made easy. It stresses the many uses of different types of test equipment; it gives you short cuts in trouble-shooting and repairing; and, contains over 250 pages of operating notes on 1,000 manufactured receivers. So up-to-date is the **OFFICIAL RADIO SERVICE HANDBOOK** that it explains thoroughly what to do when a receiver with the "Magic Eye" goes "cockeyed."

Service Men, previously advised about this great book on servicing, have already ordered their copy. Order your copy NOW if you have not already done so.

SENSATIONAL PRIZE CONTEST!

\$1,800 Worth of Prizes to Be Awarded to Service Men

You should be interested in entering one of the greatest radio contests of all times. There are 147 prizes in valuable servicing equipment and radio accessories, totaling over \$1,800, to be distributed. All the details about entering this contest, including a complete list of the 147 prizes, will be sent upon request—simply mail the coupon below.

Partial Contents of this Great Book

PART 1—CIRCUIT THEORY AND ANALYSIS

R.F. Fundamentals; Superheterodyne Receiver Theory; A.V.C. and Tuning Indicator Circuits; A.F. Fundamentals; Power Supply Theory and Circuits; Speakers, Reproducers and Pick-Ups; Commercial Receiver Circuits of All Types, How to Analyze.

PART 2—MODERN SERVICING AND TEST EQUIPMENT

Fundamentals of Metering and Test Equipment; Standard Servicing Instruments; The Cathode Ray Oscillograph and Associate Instruments; How to Build Essential Servicing Test Instruments.

PART 3—PRACTICAL SHORT-CUTS IN TROUBLE SHOOTING AND REPAIRING

Localizing Trouble by Inspection Methods; Short-Cuts with Test Instruments; How to Quickly and Properly Perform All Types of Repairs; Unusual Servicing Experiences; Tube Troubles and Characteristics.

PART 4—SPECIALIZED RECEIVER AND INSTALLATION DATA

All-Wave and High Fidelity Receiver Servicing and Installation Data; Auto Radio Receiver and Installation; Specialized Servicing and Installation (Remote Tuning Controls, Home Recording, Automatic Record Changers, Apartment House Antennas, etc., etc.); Eliminating Noise Interference.

PART 5—MODERNIZATION AND CONVERSION DATA

Modernizing and Improving Methods for All Types of Receivers; Converting A.C. Receivers for D.C. Operation and Vice Versa.

PART 6—SOCIAL AND ECONOMIC PROBLEMS OF THE SERVICE MAN

Improving Knowledge and Technique; Social Problems—How to Organize, Listing of Servicemen's Organizations; The Future of the Servicing Profession.

PART 7—OPERATING NOTES AND PRACTICAL DATA LISTINGS

Operating Notes on Over 1,000 Receivers; I.F. Peaks of Approximately 3,000 Receivers; Voltage Dividers for 300 Receivers, Speaker Field Listing; Radio Mathematics and Measurements.

CLIP MAIL COUPON TODAY!

GERNSBACK PUBLICATIONS, Inc., 99 Hudson Street, New York, N. Y. RC-236

Gentlemen: Enclosed you will find my remittance of \$3.00, to cover the Pre-Publication Price for a copy of the **OFFICIAL RADIO SERVICE HANDBOOK**. The regular price of this book upon publication will be \$4.00. **YOU ARE TO SEND THIS BOOK TO ME POSTAGE PREPAID.** It is understood that, should the **OFFICIAL RADIO SERVICE HANDBOOK** ever be offered for sale by a reputable mail order house or dealer for less than this amount, you will refund the difference to me.

SEND ME IMMEDIATELY THE CONTEST BLANK FOR ENTRY IN THE \$1,800 PRIZE CONTEST.

Name _____
Address _____
City _____ State _____

(We accept cash, stamps, money orders or U.S. checks in connection with this offer. If you send cash, be sure to register your letter.)

THIS SPECIAL PRE-PUBLICATION OFFER EXPIRES FEBRUARY 15, 1936

GERNSBACK PUBLICATIONS, INC.

99 Hudson Street

New York, N. Y.

Please Say That You Saw It in RADIO-CRAFT

I'LL TRAIN YOU *Quickly* FOR SPARE-TIME AND FULL-TIME JOBS IN **ELECTRICITY**



BY PRACTICAL SHOP METHODS
in your spare time
RIGHT IN YOUR OWN HOME

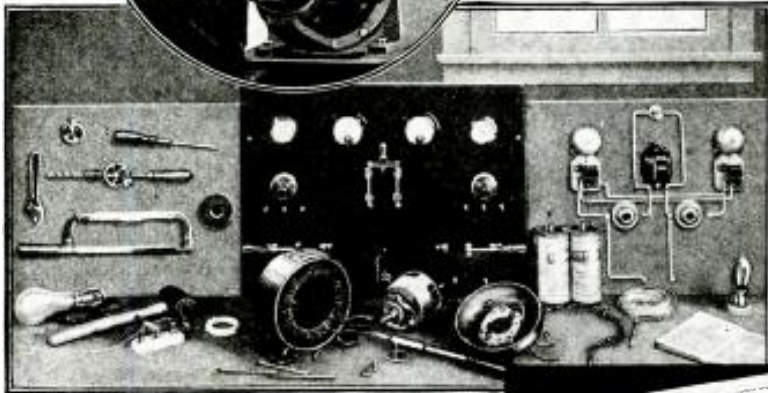

Learn to earn up to \$50 a week or more in a real money-making field. Electricity today offers opportunities undreamed-of a few years ago... steady jobs... interesting work... good pay... a real future. And now Electric Institute brings — to your very door — the practical training necessary to qualify for the rich rewards that are waiting. There is no need to give up your present job... no need to leave home, family and friends... no need to travel hundreds, perhaps thousands, of miles to some distant city; pay out large sums of money for traveling and living expenses. Now, you can learn Electricity by a simple, easy, practical method... right at home... at a fraction of the cost of going away to school... and with full assurance of your money back if you're not entirely satisfied.

LEARN BY DOING ACTUAL JOBS IN YOUR OWN ELECTRICAL WORK SHOP... WE FURNISH EQUIPMENT

Electricity is a practical subject which must be taught in a practical way. That's why we furnish each of our students with dozens of items of real electrical equipment and apparatus in addition to his course of study... so you can do the actual work on real electrical jobs... make tests... perform your own experiments. This equipment is furnished without extra cost, not only to aid your training, but to be used to go out and do real jobs... real installations and repairs that you can get real money for. In fact, by doing only two or three such jobs a month your training should actually pay for itself... and the opportunities for extra spare-time earnings are simply amazing!

YOU DON'T NEED PREVIOUS EXPERIENCE OR A LOT OF BOOK LEARNING TO PREPARE FOR JOBS LIKE THESE:

New electrical projects, constantly increasing use of electric power, means more jobs for men with practical training. There is scarcely a large industry today that does not use trained electrical men in some part of their work. Maintenance work, lighting and illumination, automotive electricity, manufacturing, service and repairs, power plant work, switch-board operation, sub-station operation... all offer real opportunities to trained men who can qualify. Or, if you prefer to own and operate an electrical business of your own, Electric Institute training and the equipment furnished will give you a start.



H. W. PETERSON
President, Electric Institute



THIS FREE BOOK TELLS YOU HOW

DIESEL ELECTRIC POWER, RADIO and REFRIGERATION

Complete course includes practical training in Diesel Electric Power, Radio, Electric Refrigeration and Air Conditioning. Start NOW and prepare to take advantage of the opportunities that are waiting for trained men in these fields and many other branches of Electricity. It's easy to get all the facts about Electric Institute Training... it takes only a postage stamp to mail the coupon... and that little coupon may be the turning point in your life, if you'll give it a chance.

—EARN EXTRA MONEY BY DOING PART TIME JOBS WHILE LEARNING!

Opportunities to make \$5, \$10, or more a week while training.

By the most practical, most amazingly easy method of home shop training, the fascinating mystery of electricity is unfolded to you step by step in a way that anyone can quickly understand and which is intended to make you a real practical trained man and not a theoretical engineer. I have designed this course so that it is possible for my students to start earning money almost at once. Do not confuse Electric Institute Training with a theoretical course, with dry text books and tiresome theories. By this new method, you are told—in plain, simple words—exactly what to do, and why... then you do the actual jobs, with real, full-size electrical equipment which we furnish without extra cost as a regular part of your training. That's the modern, easy Electric Institute way to become a practical skilled electrician in your spare time without leaving your present job until you are ready to step into a real electrical job.

GET INTO A GROWING FIELD FOR BIG PAY AND A FUTURE

There is no better way to succeed in life than to train for specialized work in an industry that is expanding. Such opportunities are waiting in the great and growing field of Electricity, where trained men are always needed. And Electric Institute is ready to show you the way. Mail the coupon now—TODAY—for Big, New, Free Book and all facts about this revolutionary plan of home shop training. There is no obligation, and no salesman will call on you. The book costs nothing... but it may be worth a fortune to YOU!

RUSH THE COUPON...TODAY!

H. W. Peterson, President
ELECTRIC INSTITUTE, INC.,
5840 Addison St., Dept. 156B, Chicago, Ill.
Send Free Book with all facts about E. I. Home Shop Training.

Name..... Age.....

Address.....

City..... State.....

ELECTRIC INSTITUTE, Inc. H.W.PETERSON
5840 ADDISON STREET, Dept. 156B, CHICAGO, ILLINOIS PRESIDENT

Please Say That You Saw It in RADIO-CRAFT

Special Announcement

To-date we have issued the following publications of vital importance to service men:

1931 Official Radio Service Manual

1932 Official Radio Service Manual

1933 Official Radio Service Manual

1934 Official Radio Service Manual

1935 Official Radio Service Manual

Official Auto-Radio Service Manual (Vol. No. 1)

Official Auto-Radio Service Manual (Vol. No. 2)

Every Service Man, in order to be properly equipped to service the older sets, which naturally cause the most trouble, should have the complete set of these manuals. With this end in view we are desirous of making a special proposition to anyone who has some of these manuals but not the complete set.

If you will be good enough to fill in the coupon appearing below, and mail it to us, we will make you a proposition to enable you to fill in the missing manuals and pay for them on an installment proposition.

**MAIL
COUPON
TODAY!**

Gernsback
PUBLICATIONS,
INCORPORATED

99 HUDSON ST. NEW YORK, N.Y.

Gernsback Publications, Inc.
99 Hudson St., New York, N. Y.

RC-236

I now own the following manuals (check the one you now have).

- 1931 Official Radio Service Manual
- 1932 Official Radio Service Manual
- 1933 Official Radio Service Manual
- 1934 Official Radio Service Manual
- 1935 Official Radio Service Manual
- Official Auto-Radio Service Manual (Vol. No. 1)
- Official Auto-Radio Service Manual (Vol. No. 2)

Will you kindly mail me a special proposition whereby I may secure the missing ones. It is distinctly understood that the sending of this coupon does not obligate me in anyway.

Name

Address

City State

Please Say That You Saw It in RADIO-CRAFT



NEEDED BROADCAST REFORMS

An Editorial by HUGO GERNSBACK

EVER SINCE broadcasting became in itself a great industry—growing up like Topsy as it were—it has assumed a quite detached existence from the remainder of the radio industry as a whole.

With very few exceptions—such as the handful of broadcast stations controlled by radio manufacturing companies—broadcasting has chosen to travel a road which is diametrically opposite to the one taken by the remainder of the industry. The broadcast industry today of course is in business, first, to make money; and second, to furnish entertainment to the American public. As a money-making instrumentality some of the larger stations have been quite successful, but from the standpoint of entertainment the success has not been so great.

Even our key stations, affiliated with the national chain networks have often found it necessary for financial considerations to accept highly questionable business, the sort of business that first class newspapers or magazines would certainly never take. By this means, the broadcast industry has been able to get great financial rewards, but unfortunately at the expense of the public.

It is true, of course, that there are notable exceptions to the above. There are a number of first-class stations which transmit excellent programs year in and year out, and which do not offer questionable merchandise and patent medicines over their stations. However, such stations are the exception.

Wherever a person discusses radio broadcasting today he finds a great deal of dissatisfaction among the listening public as to the quality of programs. For every good feature broadcast by a network, there are ten mediocre—or even downright poor, programs which clutter the air at practically all times.

It would seem that all broadcasters must realize that to hold their audiences the first requisite is worthwhile programs, but this truth appears never to have dawned on the majority of broadcasters. They still go out to grab everything in sight when it comes to business, accepting the most blatant and untruthful advertising, which is dinned into an unwilling public's ears, and which, nine times out of ten, causes listeners to tune out the offending station!

It is true that if the stations are to continue in operation they must have business—that is, their programs must have sponsors. There is no question of this under our present American broadcast system, and that this system is sound has been demonstrated during the past decade. But it also has been demonstrated that the advertiser will still get his share and will still be benefited if the listener's intelligence and sensibilities are not shocked in the way they so often are today.

The public instinctively knows that it owes a debt to the broadcast stations for the free entertainment, but the broadcasters do little to get the good will of the public and keep it.

It is a curious fact that some of the most successful advertisers over the air are those who do not revert to trick selling, who do not offend their listeners, but use their advertising "blurbs" inoffensively and discreetly. And to this,

the public does not object.

The great trouble with business concerns wishing to go on the air is that they expect to get results over night; unless they get such results they often are unwilling to go ahead with their sponsorship. This is the crux of the whole business, and explains why short-sighted broadcasters in desperation are allowing the sponsors to broadcast the huge quantity of offensive advertising that nowadays goes on the air. Successful sponsors, on the contrary, have found that results cannot be had over night; and that it takes months and sometimes years before the expense warrants the business derived—but in the end, it always pays.

Your patent or proprietary medicine manufacturer however does not seem to be interested in the long pull, and in the good will of the public. He wants immediate results—he wants to move merchandise.

To the disgrace of the American broadcasting industry it must be stated that, with practically no exceptions, all patent and proprietary medicines hawked over the air today are worse than useless and a menace to the health of the American public. If you doubt this, read such books as "100,000,000 Guinea Pigs," or the new book recently published by the same authors, "Eat, Drink and Be Wary."

The huge number of fake patent medicines and other questionable food products ballyhooed over the air is a mute testimony to the gullibility of the American public. It is doubtful that there are a half-dozen medical and food products now being advertised by radio which would pass the test of the American Medical Association. At any rate, few of the articles would be acceptable to that discriminating body.

It is to be hoped that the Federal Communications Commission will some day step into the picture and rule that any medical, proprietary or food article must first have the endorsement of the American Medical Association before it can be advertised over the air. While it is true that if this plan was put into effect few such articles would be advertised over the air, it is even more to the point that such a ruling is warranted if public interest—the health of the American people, is at stake.

Naturally this raises a question as to the entertainment value of the programs themselves. It is the consensus of opinion that programs in the United States have not greatly improved. If you use as standards of comparisons the programs offered by the largest and networks-key stations, the remaining, smaller stations seem to put out worse programs as time goes on. In practically all cases we still have mediocre music and mediocre talent. The few good programs sent out by the smaller stations invariably are "electrically transcribed" (that is, they are phonograph records). In fact, nine times out of ten their only decent programs are these same "transcriptions" or phonograph records. And, of course, the sponsored programs of these small stations are, as a rule, highly offensive to the listeners due to the blatant sort of advertising that is broadcast day in and day out.

This observer has noted little change toward improvement of radio programs during the last five years; at this rate the future does not look very bright.

THE RADIO MONTH

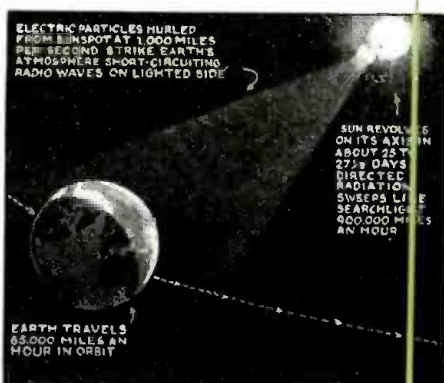

The effect of the solar cycle on short-wave communication is shown.

RADIO FADING LINKED WITH SUN'S ROTATION

FADING of radio signals, especially on short wavelengths, has long baffled scientists, and though various theories have been presented from time to time purported to explain this phenomenon, they have lacked scientific proof.

Last month, however, Dr. J. H. Dellinger, chief of the radio section of the Bureau of Standards, presented evidence that fading periods are predictable on the basis of the rotation periods of the sun, and that sharp fading cycles of 15 minutes duration occur at intervals of two rotations of the sun (54 days).

Following this, Dr. H. R. Minno of Harvard University, in an article published in *Science* went a step further by presenting records tending to show that the fading cycle noted by Dr. Dellinger occurs every sun rotation of 27 days!

At the same time, Dr. Minno "took a crack" at the Federal Communications Commission for holding up research progress. He said—"During the past sixteen months the F.C.C. has repeatedly postponed the re-phrasing of certain obsolete regulations limiting the use of automatic apparatus, which effectively block the continuation of fundamental research . . . Already an important part of the sun-spot cycle has been completely lost by governmental decree."

INDIAN RULER TO BUY 20,000 SETS

LAST month, news came from far off India that His Exalted Highness the Nizan of Hyderabad is buying 20,000 radio receivers, one for each of his 20,000 villages. These will be used to allow his 15 million or so subjects to listen to the jubilee, Feb. 1936, in honor of his 25th year of reign.

He is also going to install 4 modern broadcast stations. Transmissions will be in English, Hindustani, Telgu, Marahti and Canarese native dialects.



Several of the fleet of P. A. trucks sent throughout Italy are shown above.

ITALIAN P.A. TRUCKS FIGHT SANCTIONS!

A NEW use for sound trucks was originated in Italy, last month, when a fleet of these cars was sent on a tour throughout the country to instruct the people in the art of passive resistance to the sanctions applied by the League of Nations.

Addresses were made at each wayside town, the entire population gathering around the truck.

Another interesting high-light of the Italo-Ethiopian conflict is the situation in international broadcasting. First, when Baron Pompeo Aloisi, chief Italian delegate to the League of Nations attempted to broadcast a speech to the U. S. via a British Broadcasting Co. relay (a standing agreement between American and European stations) the B.B.C. refused to complete the relay. This necessitated setting up a relay from France and disrupted the long-standing international program exchange agreement.

Later, when Guglielmo Marconi made arrangements to broadcast from England, the B.B.C. again stepped in and refused permission. Marconi broadcast to the U.S. twice, recently, directly from Italy.

ELECTRON MULTIPLIER DISSENTION

THE introduction, recently, of the Zworykin electron multiplier tube (see *Radio-Craft*, Jan. 1936, page 391) started what promised to be a grand and glorious court battle.

Last month, Philo T. Farnsworth, who is well known for his television experiments and the invention of his "multipactor" tubes, gave a talk before the Washington chapter of the I.R.E. on the various types of electron tubes developed in his laboratory.

Since Zworykin's tubes work on similar principles, dissention is expected. There is little doubt but that court action will be taken by one or the other!

METAL VS. GLASS TUBE FIGHT—CONTINUED

THE fiery accusations which Philco has been flinging at G.E. and its licensees for introducing the metal tubes, which the former claims are not yet ready for the market, brought forth a retaliation, last month, when 47 manufacturers of metal tube sets (at the instigation of G.E., no doubt) banded together and placed a full-page ad. in the *New York Times* and other papers throughout the country. The names of all manufacturers were listed and the page was ended with the slogan "Be modern—get a radio set with Metal Tubes."

Well, there's one thing certain—the newspapers are not going to complain, however long the fight lasts!

RADIO SET FIGURES AND FACTS

THE United States has lost slightly on its tremendous lead in the possession of radio receivers among the countries of the world, but the lead is still far from being threatened. Out of 56,221,784 sets in the world, Uncle Sam has 25,551,569. Not so long ago, the U. S. had more than half the sets.

Statistics published last month by the Electrical Division of the Bureau of Foreign and Domestic Commerce show the United Kingdom runs far behind in second place with 7,055,464 radio-equipped homes. Actually, it has more sets than that because additional sets may be operated with only one permit.

Germany comes third with 6,516,732; France has 2,763,123; Russia, 2,000,000; and Canada 812,335.

The distribution of radio sets by continents follows:

North America	25,632,981
South America	1,088,374
Europe	22,897,981
Europe-Asia	2,010,000
Asia	2,553,396
Oceania	829,851
Africa	209,201

The distribution of radio sets in the world can be seen at a glance from this map.

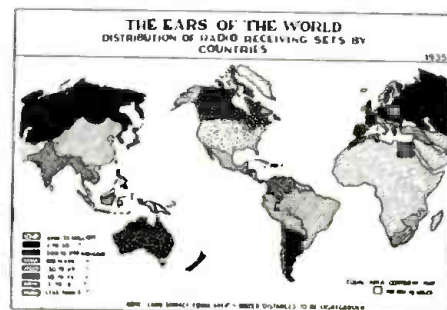

IN REVIEW

Radio is now such a vast and diversified art it becomes necessary to make a general survey of important monthly developments. RADIO-CRAFT analyzes these developments and presents a review of those items which interest all.

HEARING-AID SALE RULED ILLEGAL!

THE State Board of Medical Examiners of New Jersey in reporting cases in which the Medical Practice Act was enforced included, last month, a case of interest to many radio men.

The case which was described in *Medical News* stated that: "Cleon E. Shields, Newark, pleaded guilty to practicing without a license and paid the penalty. Shields claimed to improve impaired hearing by the use of a device which he said measures the capacity to hear and furnishes in correct volume the tones that are 'blocked out' by the impairment."

If individuals and companies selling hearing aids are thus prosecuted for practicing medicine without a license, a large number of radio men and companies will be liable!

AMOS 'N' ANDY MISS FIRST BROADCAST

LAST month was an outstanding one with radio listeners in the eastern states as the first time in over eight years that Amos 'N' Andy missed their nightly broadcast. The two blackface comedians were on a wild turkey hunt near Hancock, Md.—the hunting was good!

SECRET FACSIMILE TRANSMISSION

AMETHOD of secret facsimile transmission for telephone lines and radio was announced last month by the famous French television pioneer—Edouard Belin.

Monsieur Belin, who presented his invention to the French War Department guarantees that messages, even though they are intercepted by wire tapping or radio reception will be so garbled that they will be absolutely incomprehensible. It is expected that this system will prevent the leakage of messages in case of war.

Below, Belin's apparatus for secret facsimile transmission; inset—actual transcript.

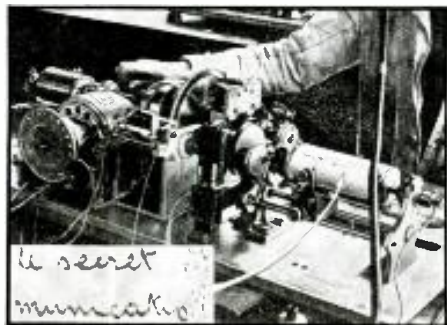

The portable transmitter on the S.S. Manhattan.

NEW PORTABLE TRANSMITTER USED BY WOR

STATION WOR made use of a new portable 7-meter short-wave transmitter for the first time last month, at the home-coming of New York's Jimmy Walker.

The tiny portable unit was installed aboard the S.S. Manhattan and within 10 minutes was in communication with the receiving point. The latter was located on one of the down-town skyscrapers.

The use of this portable short-wave transmitter not only facilitated the broadcast pick-up but also aided newspaper reporters who were able to relay messages to their city desks.

RCA SECRETLY PREPARES TELEVISION APPARATUS

FOLLOWING the plan outlined several months ago in *Radio-Craft*, RCA and NBC engineers were reported last month to be dismantling the old television equipment in the tower of the Empire State Building, preparatory to installing new and modern equipment.

The work, however, is being carried out in utmost secrecy and no definite date could be ascertained when the transmitters would be ready for operation. From unofficial sources, we learn that the transmitter will be completed sometime in January.

It is understood that the plan calls for the manufacture of some 500 receivers of four different designs which will be placed in research outposts and the homes of observers to facilitate a complete check on the system. It is expected that one of the four designs will be chosen for manufacturing purposes.

The images will be sent out over a 15 kw. transmitter on a wavelength of about 6 meters. The images will measure about 9 by 10 ins. and are said to be very clear.



Enoch Light and his orchestra are shown above with the sound measuring apparatus.

N. Y. ORCHESTRAS COOPERATE WITH ANTI-NOISE COMMITTEE

PROGRESS was reported last month in New York's anti-noise campaign due to the voluntary cooperation of "Tin-Pan-Alley." Practically all the metropolitan hotel orchestras under the leadership of Enoch Light, well-known baton wielder, offered to cooperate; and, subsequently db. meters (noise level indicators) were used to determine the most comfortable hearing levels for playing popular tunes in the ball rooms and restaurants of the respective hotels.

This was done not only to keep the volume at the lowest convenient level for sleeping hotel guests' comfort, but also to prevent the hotel entertainment from increasing the street-sound level, especially in summer.

It was announced that during the first month of the anti-noise campaign, the noise level at Times Square dropped an appreciable amount.

F.C.C. PLANS STATION SHIFT

THE Federal Communications Commission announced last month that they are working on a plan to eliminate the duplication of network programs, throughout the U.S.

This will involve a proposed reduction in the number of clear channels from forty to twenty-five and the requirement that these stations maintain an output of 500,000 watts instead of the 50,000 watts now required. It will be remembered that there is only one 500,000-watt station now operating—WLW.

The purpose of this re-allocation is to better serve dwellers in rural districts, who are fast becoming a most important part of the listening public!

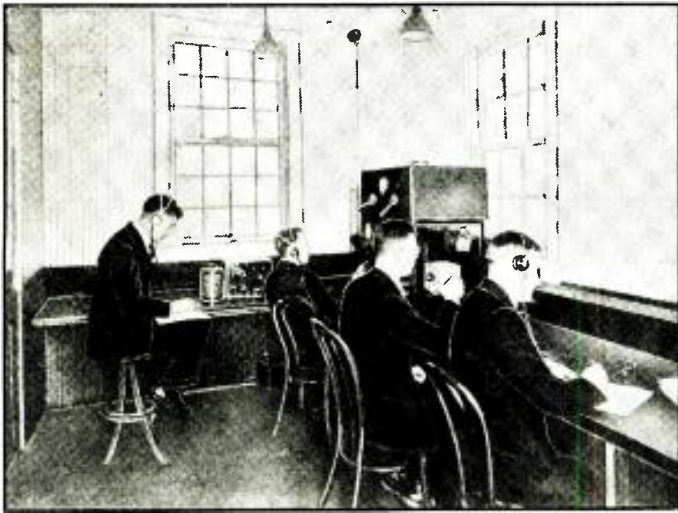

MILESTONES

In this article the author presents a cross-section of radio broadcasting from 1919 to date. The 25 million radio receivers now in use are analyzed from all angles, and conclusions drawn concerning the probable trend of the industry. Everyone interested in radio should read this valuable article. (Other references are given at right.)

Dr. Conrad and associates starting the American broadcast industry on Nov. 2, 1920. KDKA sent Harding-Cox election returns.

WE ARE now in the 16th year of American Broadcasting. The daring idea of youthful David Sarnoff in 1919 when he predicted the future of broadcasting has grown into a vast industry with many millions of dollars invested and providing thousands of workers with jobs which did not exist before broadcasting started.

No one knows what the directors of RCA thought of this prediction which was included in a report from David Sarnoff—who had just been appointed commercial manager of the company—but it is not hard to guess that they did not consider it seriously or with much confidence.

However, despite this fact, only one year later, on Nov. 2, 1920, Dr. Frank Conrad and his staff of Westinghouse engineers broadcast over KDKA returns of the Harding-Cox presidential election—and thus staged what was perhaps the birth of American broadcasting.

Since that time broadcasting has continued to grow by leaps and bounds and is at present an important factor in the progress of all civilized nations.

David Sarnoff has also grown. This former telegraph boy who had a weekly income of \$5.50 at the age of 15 became, in 1930, when only 39 years old, the president of RCA. Now, however, after having so much experience with radio and broadcasting, he is quite tight-lipped with regard to the future of radio, and recently—during an interview with Mr. Orrin E. Dunlap of the *New York Times*, said the very meaningful words: “. . . Those of today cannot foresee the radio of a generation hence!” And no one can blame him for his attitude, because of tremendous strides made in the first 15 years of American broadcasting.

Fig. 3. Radio sets in public reduce sales resistance.

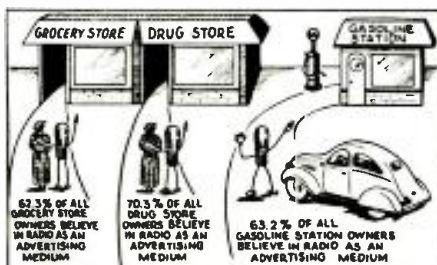

OVER 25 MILLION SETS IN USE

To give a simple picture of broadcasting today we may start with the plain fact that on the first of January of this year (1935)* there were about 22,000,000 home radio receivers in use, and about 2,400,000 auto sets in use in the U. S. (*See page 454.—*Editor*.)

What the figure of 22,000,000 home radio receivers involves may be seen from the fact that it was 50 years before 10 million telephones were in use in America. Let's take these 22 million home sets and pile them up.

But this trick of statisticians involves difficulties where radio sets are concerned, because within the last 15 years about 10,000 different receiver models have been put on the market. There are large consoles and tiny midgets, and table models of medium and large size. Although it is difficult to agree on an average size, by careful estimations the average size has been found to be about 24x16x9 ins.

With these figures as average dimensions, all 22 million radio receivers piled one on top of the other will give a pillar towering about 8,000 miles!

If this colossal number of radio receivers now operating in American homes is pictorially represented, as in Fig. 1A, by dividing the 44,000,000 ft. pillar into 500 single ones having base dimensions of 24x16x9 ins., each pillar would be about three times as high as Mount Everest (highest mountain in the world, which towers about 30,000 ft. into the air.

Now let us group these 500 single pillars to form a tower having base dimensions of about 30x16 ft. deep. Then, taking \$50 as an average value per set, this tower would represent \$1,100,000,000. Since the president of the U. S. receives a yearly salary of \$75,000, the value represented by these radio sets would be sufficient to pay the salaries of all American presidents for the next 14,666 years!

LISTENERS ARE THE FINANCIAL POWER OF BROADCASTING

That the main part of American broadcasting has been financed by the radio listener is shown impressively by Fig. 1B. The value of all American

broadcast stations including equipment and goodwill is only \$60,000,000. The value of all commercial stations including radio investment on American ships is estimated at about \$40,000,000. Radio factories are valued at about \$80,000,000, and the value of American radio retail and wholesale houses may be quoted as being about \$50,000,000.

These 4 branches of radio represent a total investment of about \$230,000,000 which is a little more than 1/2 the value of all radio receivers in use at present in American homes.

There are, as Fig. 1D shows, about 581 broadcast stations in operation in America. More than 31 of them have a power output at the antenna of about 50 kw. One station, WLW, Cincinnati, the world's largest broadcast station, has an antenna power of 500 kw.! But these 581 stations representing a value of about \$60,000,000 produce an annual gross revenue of about \$90,000,000 which is certainly a worthwhile business for the owners of these stations.

Very interesting also are the relations between the estimated value of the American radio factories and their yearly turnover. In the year 1934, American radio manufacturers sold approximately 4,696,000 radio receivers (this figure includes the export sales of about 612,000 sets), having a total retail value of about \$250,390,000. The figures for 1935 amounted to 5,500,000 units (including export) representing a retail sales value of about \$300,000,000. This increase is due to a greater demand for consoles in 1935, and also to the higher average prices for these different types of receivers. (See also Fig. 1C.)

As Fig. 1E indicates, the radio listeners spend yearly for operating expense about 2.2 times as much as the payroll figure for the manufacturing and distributing side of the broadcast industry. That is, the yearly bill for the 800,000,000 "kilowatt-hours" used to operate radio receivers amounts to a sum which easily surpasses the yearly payroll of all American broadcast stations. Also, the total kw.-hour energy used by radio receivers is greater than the total of kw.-hours used by each of the domestic home appliances represented in Table I.

IN BROADCASTING

Radio-Craft, in presenting this comprehensive review of the latest facts and figures concerning the radio "business," supplements the valuable data contained in the following, previously-published industrial reviews.

"The Broadcast Industry," and "A Modern Picture of Broadcasting," Feb. '35; "A Modern Picture of Television," April and May '35; "The Growth of Public Address," May '35; "The Present Status of Automotive Radio," June '35; "The Radio Service Industry," and "The Radio Service Business," July '35; "World-Wide Television," Aug. '35; "Some Facts About Radio As a Career," and "New Opportunities in Radio," Nov. '35; "Television in the Theatre," Nov. and Dec. '35; and, "Television and Ultra-Short Waves," Jan. 36. (Radio Month in Review items contain additional data.)

WILHELM E. SCHRAGE

TABLE I

Estimated total amount of energy used by domestic electrical appliances

Appliance	Kilowatt-hours
Radio Receivers	800,000,000
Flatirons	673,000,000
Vacuum Cleaners	235,600,000
Washing Machines	131,000,000
Toasters	152,000,000
Percolators	106,000,000
Heaters	48,000,000

LISTENER INFLUENCE ON PROGRAMS

Because of these important financial relations it would be usual to expect that the radio listener has a tremendous, direct influence upon the program planning. However, this is not the case! Despite the fact that the American broadcast stations receive yearly about 5,000,000 letters (which are carefully filed, as far as the networks are concerned), the direct influence of individual listeners upon the program planning is about ZERO! There are, of course, some women's organizations in America which have quite a bit of influence on the kind of programs presented, but even their power is restricted, since program sponsors have the last word in this respect!

However the indirect influence of the radio listeners as a whole on the kind of radiated programs (which are about equally proportioned, as shown by Fig. 2A) is about 100 per cent. A survey made by The Psychological Corporation, New York, by order of the NBC, unveiled many interesting facts as to just how the public is influenced by radio. By means of a very interesting method (which is described with all details in a booklet—prepared by Dr. Henry C. Link—entitled, "A Study of

the Relative Effectiveness of Major Advertising Media) a great many retail dealers have been asked how far they believe radio broadcasting is a fitting vehicle for advertising messages. This was done because it is realized that the radio broadcasting lacks the great imp- or explain the advertising forces which influence his preferences. Since the dealer is actually the clearing house of customers' reactions, this survey (the results of which are shown in Fig. 3) is highly interesting.

It shows that the public *en masse* has about 100 per cent control of the programs presented, because only programs which suit the public taste will find listeners. Since there are only a few program sponsors who would dare to present to prospective customers a performance which did not produce popular satisfaction, the broad mass of radio listeners really has a very effective control of American broadcasting.

Inversely, the great influence of radio broadcasting has had a great effect upon listeners; this buying public (see Fig. 3) has greatly effected the amount of advertising appearing in national newspapers. According to *Radio Today* (which compiled the diagram shown in Fig. 4), many newspapers and magazines had a decrease in advertising because of radio broadcasting. According to the above-mentioned magazine a quarrel is going on between the newspapers and broadcast stations, and as always in such cases, both sides are fighting for the patronage of the manufacturers of nationally advertised brands.

METAL CONTRA GLASS TUBES

But this quarrel in the evolution of radio broadcasting lacks the great importance of another combat which has its battlefields directly among the American radio manufacturers. This fight which is drawing much attention in the broadcast industry, is the one of metal versus glass tubes.

According to the defenders of the metal tube, 47 manufacturers are using metal tubes in their sets. This fact published as full-page advertisements in many daily newspapers proves nothing, because there are other facts which enter the picture. (Continued on page 489)

Fig. 4. Increased revenue by "commercials" may be attributed to more effective use of radio as an advertising and publicity medium, as this figure illustrates.

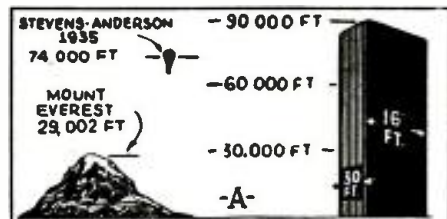
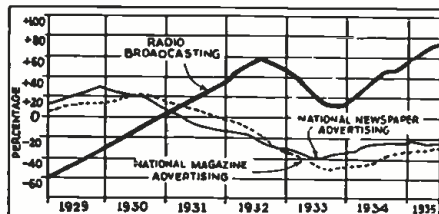

VALUE OF AMERICAN RADIO INDUSTRY

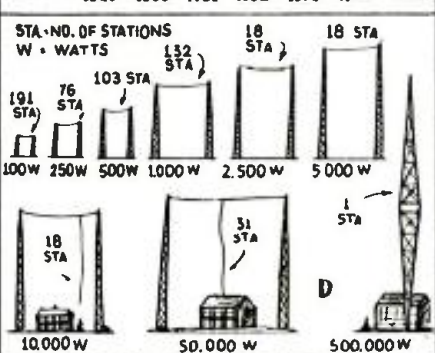
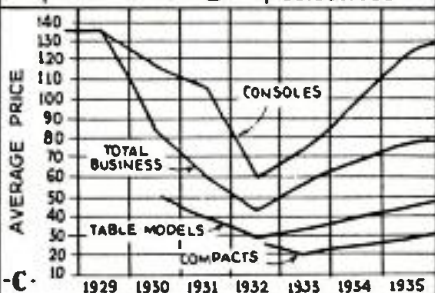
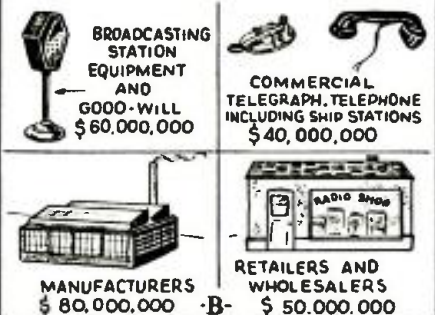
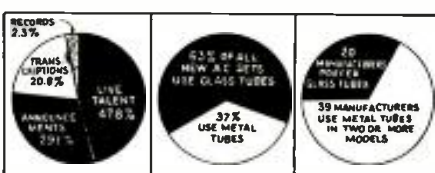

Fig. 1, above, and Fig. 2, below. These illustrations visualize some modern facts concerning radio.



RADIO PICTORIAL

Recorded sound effects for radio broadcast work; short-wave car-relays; novel sets.



INSTANTANEOUS SELECTION OF SOUND EFFECTS. This device enables a studio technician to select any one of a group of sound effects on a single recording. The pickup arms are set by turning a graduated dial to the number of the required effect. Then, when a button is pushed, the arm swings to the exact spot required and the needle drops smoothly onto the record. Two turntables are used so that the operator may always have the required sound ready. The view below (right) shows a close-up of dial and tone arm. (Halbran Photos)



The sound effect apparatus (developed by sound-effects specialist Al Sinton, and built by Ansley Labs.) has replaced old-fashioned equipment, and the results are better than with the old, cumbersome gadgets. An auxiliary, manually-operated tone arm may be seen between the two turntables. This is used on either turntable for additional pick-up, as required.

"GE" TO SO. AMERICA VIA CAR RADIO! This radio-equipped car was used by Henry Ford, visiting the G.E. plant at Schenectady, N. Y., in talking via short-wave relays to his Buenos Aires plant manager!

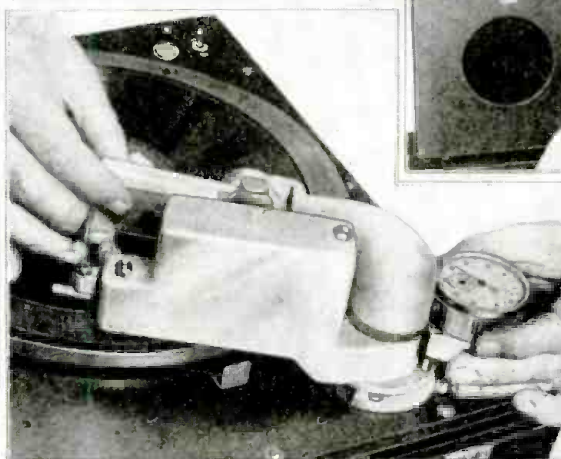

Mr. Sinton is seen adjusting the mechanism of his apparatus which selects the desired groove of the record for reproduction. The knobs on the forward side of the machine are the various volume controls.

TRANSPORTABLE SET. This set by EKCO of England has a built-in twin-loop aerial, but can be used with the conventional antenna. It includes all the latest improvements, such as delayed A.V.C., noise suppression, tone control, tone compensated volume control, shadow tuning indicator. The dial is uptilted for ease of reading, and has printed on it the names and wavelengths of the various large stations. The cabinet is of moulded bakelite with the handles an integral part.

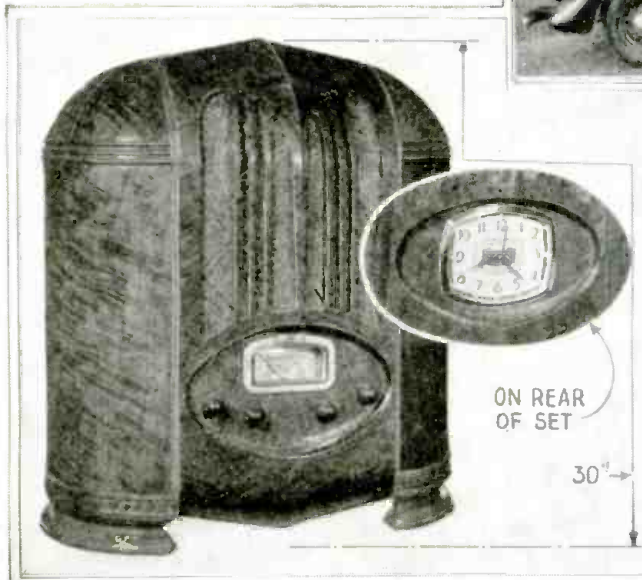
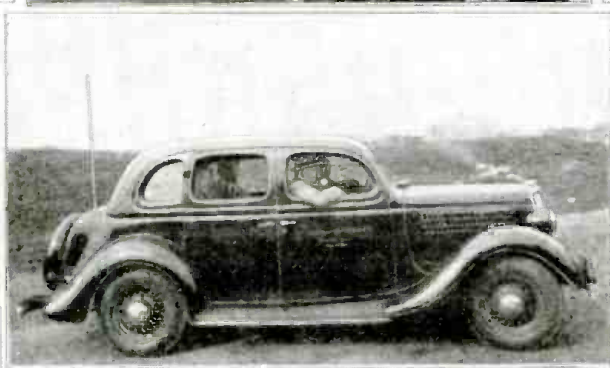

ON REAR OF SET
30"

"TWO-FACED" SET.

This novelty set, housed in a case of the finest woods, has a speaker grille on both sides. The receiver was designed for the recent Radio Show (N.Y.C.). The chassis is a 6-tube A.C.-D.C. superheterodyne with 3 ranges which cover all the popular bands in use at present. Both sides of the set are visible when the set is centered on the table. One side carries an electric clock. Since both sides of the set have a speaker grille the set will sound as well from either side.





▲ **LIFEBOAT RADIO.** This lifeboat is one of the first to be so equipped under the new F.C.C. law. The set and a searchlight are run by a group of storage batteries. Operation is possible even though the set be drenched with water!
▼
(World Wide Photos)

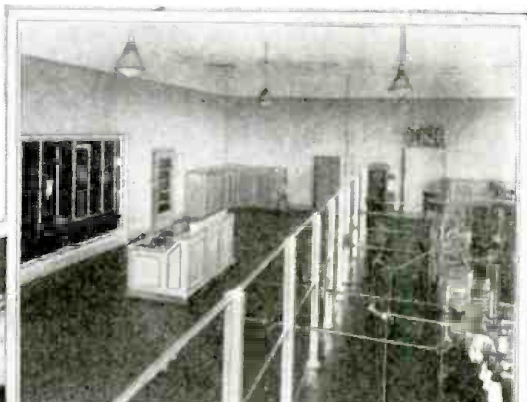

▲ **GERMAN BROADCASTER.** The transmitting room dispenses with the usual panels, using plain glass instead. The metal-framed glass serves only to keep the high power isolated.



▲ **WAVETRAP.** German device has a vernier for exact elimination of signals.
(RPS)

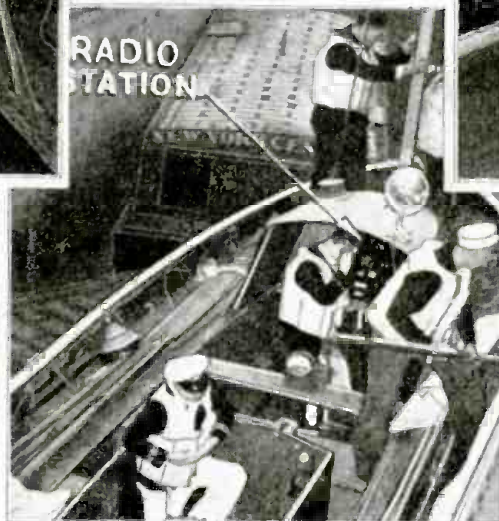

RADIO STATION

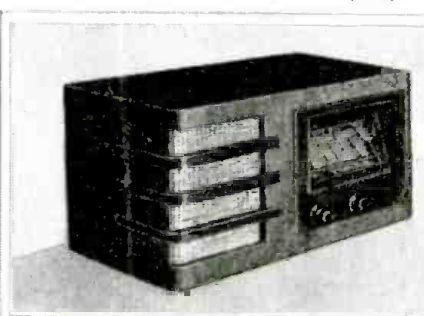

▲ **CAUTERY OUTFIT.** This medical device shows us that other trades besides the radio industry make use of this style of design. At first glance this appears to be only a midget radio set.
(Comprex)

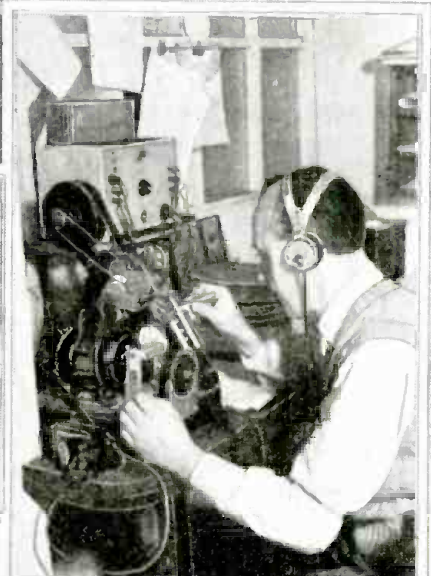
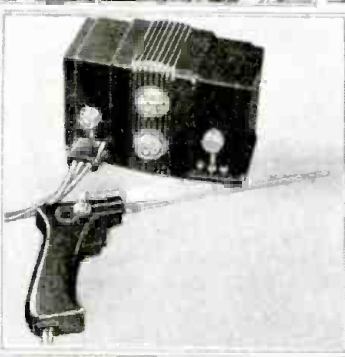

▲ **MICKY MOUSE RIVAL.** A British concern will make cartoon films of "Sam" and his musket. The operator is examining a film sound track and making a sound chart.

▲ **GERMAN 2-TUBER.** The speaker is placed alongside the chassis to eliminate cabinet resonance.
(RPS)

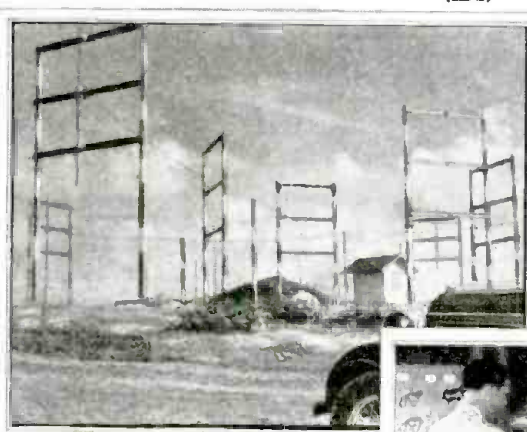

▲ **CONVERTER.** Addition for the "Peoples Receiver" converts this popular set into a modern (German) superheterodyne.
(Kutsehbach)

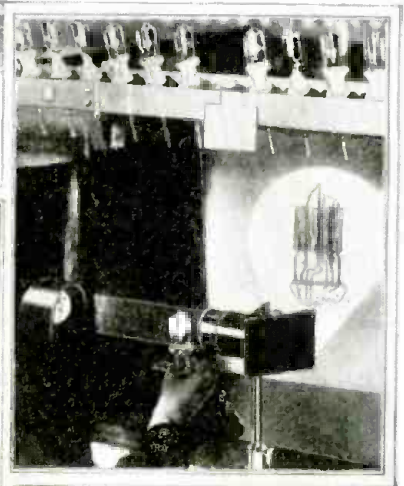

▲ **RADIO TUBE EXAMINATION.** Device which enables the inspector to examine the completed tube "mount" before it is sealed in the glass bulb. Notice the great degree of enlargement possible in the projected image of the bioscope.
(RPS)

▲ **AIRPLANE BEACON ON THE AIR ROAD TO CHINA.** Stations are being built to guide the "China Clipper" Trans-Pacific passenger plane on the new airline to the Orient. The Mokapu (near Honolulu) station is illustrated.
▲ **SEASONING RACK.** Apparatus at the right enables efficient mass production of Raytheon metal tubes. All tubes of one type are aged alike by the use of this apparatus. "Load lamps" for elements connected to the caps are above the drum; others are located inside.

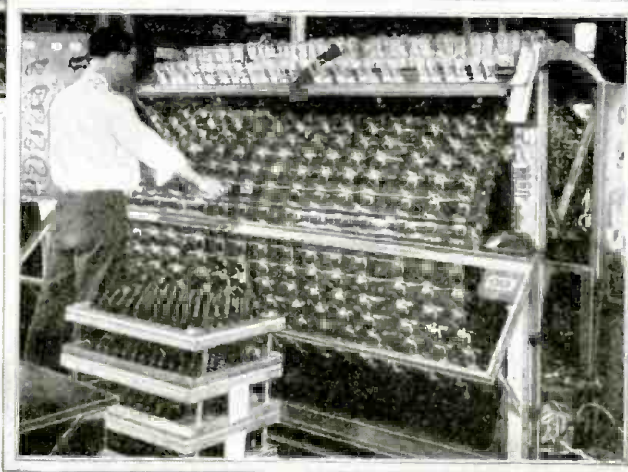

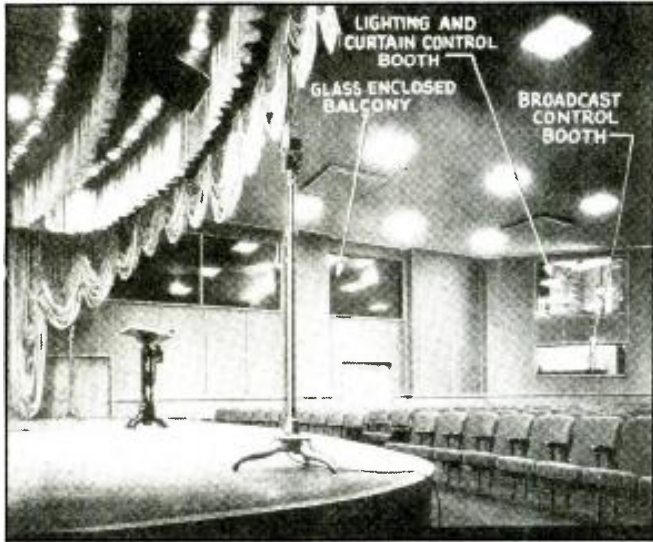

MODERN STUDIO TECHNIQUE

A few of the high-lights of building and operating a modern broadcast studio show how very complex this apparently simple work has become in perfecting the nationwide distribution of radio programs.

C. W. PALMER

ANYONE WHO has visited one of the modern broadcast studios has no doubt been struck with the "apparent" simplicity of the room compared to those used a few years ago. The word *apparent* is used because, as we will learn later, they are far from being as simple as they seem. The heavy drapes and carpets found in the old-time studios are missing and the announcer is no longer expected to be a Houdini, handling the production of the program as well as announce, act as master of ceremonies, and usher for the artists and studio audience!

The studio of today is a well-appointed room, plainly furnished—but usually rich in coloring and lighting.

Yet, under the quiet, dignified appearance of this modern studio lies all the ingenuity of the electrical, acoustical and mechanical engineer. Take for example the corner of the studio shown

in Fig. B in which Ray Kelly, chief of the NBC Sound-Effects Department is shown with a few of his latest gadgets for producing the background noises and incidental sounds required with every broadcast. The walls of this studio in Radio City are lined with rockwool blankets, varying in thickness according to the requirements of the room, and the wall finish, instead of being hard plaster of the usual type, is constructed of panels of a material known as *transite*. This *transite* is perforated on the upper part of the wall, while the wainscot is made of the same material in a solid form. *Rockwool* is chosen as the padding because of its characteristic of absorbing medium and low tones more readily than high ones. This gives the desired effect of a "dead" space for the medium and low tones and a "live" space for the high ones.

The floors of this studio are also treated in a very special way. There are 5 steps in this treatment. First, the solid concrete building floor is equipped with steel flooring channels which rest on hair-felt-covered spring clips, properly spaced to carry the anticipated load. The space between the channels, which are laid parallel the full length of the room, is covered with loose rockwool. Next a layer of heavy, black, building paper is placed over the entire floor, over which a wire mesh is then placed. Finally, a layer of concrete is poured and the finished floor is ready for linoleum. Some of these

steps are seen in Fig. C.

By this method, the drapes are eliminated and the studio has better characteristics for broadcast purposes.

An idea of the multiplicity of studios used for operating a national chain can be obtained from an examination of Fig. 1. This shows a plan view of the 8th floor of the NBC studios in Radio City. Note the differently-sized studios, each of which is used for a different type of program. There is the large auditorium studio at the right which is 132 ft. long and 78 ft. wide. This is used for large orchestras and for exceptionally popular programs where large studio audiences always congregate. To the left of this mammoth room which is two floors high and has a large balcony for the studio audience are the various smaller studios, each with its control room, from which the program is monitored. Note also the special studios for speakers and (Continued on page 498)

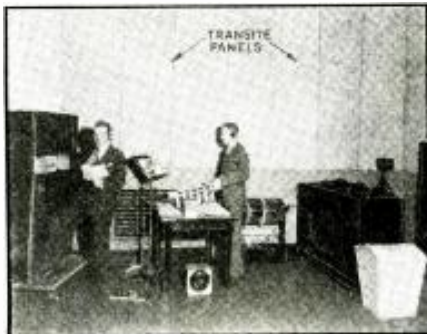
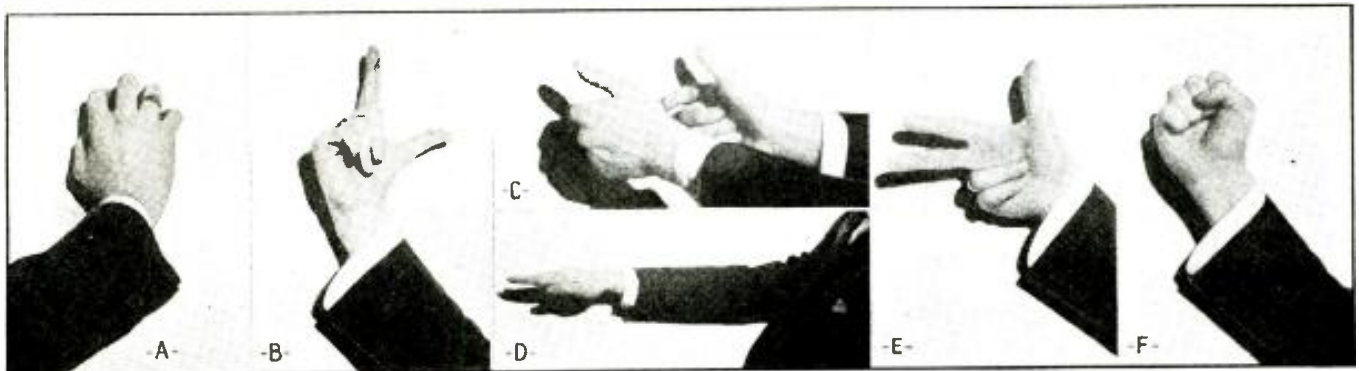

Fig. B. A corner of a modern broadcast studio.



Fig. C. Details in acoustical treatment of studios.

Fig. D. A few of the studio hand signals used to inform the announcer and artists of the progress of a studio program.



HOW TO MAKE A "FREE-REFERENCE-POINT" MULTI-PURPOSE SET ANALYZER

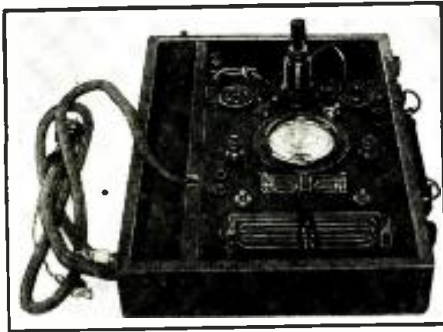

Fig. A. The unit in its wooden case.

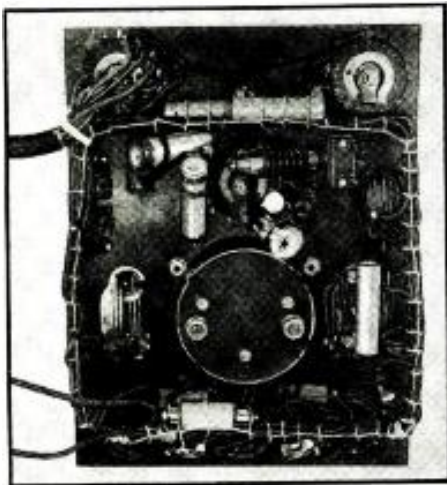

Fig. B. The "works"—note the cable wiring.

THIS TESTING instrument consists, essentially, of a universal volt-milliammeter, Fig. 2, and a free-reference-point unit, Fig. 1. Three sockets are available for current readings of all modern tubes.

Voltage scales, A.C. and D.C. of 10, 100, 500 and 1,000 are selected, as shown in Fig. 2, by means of a rotary selector-switch, Sw.6. Rotating the same switch in the reverse direction, selects current scales of 10, 100, 500

The amateur who is in need of a set analyzer and tube tester which will accommodate the latest set as well as the oldest will find this unit unusually flexible.

W. C. BELLHEIMER

and 1,000 ma. Setting the toggle switch Sw.10, cuts a 10-A. shunt directly across the meter.

Jack switch Sw.4 selects current or voltage; Sw.5, A.C. or D.C.

Resistors R5 and R10 convert the meter to a 0-5 voltmeter; R6 then completes the total resistance for the 10-V. scale.

(Carbon resistors having a 5 per cent tolerance were found accurate enough for ordinary service work.)

The current shunts, with the exception of the 10-A. shunt, are hand-calibrated from wire-wound resistors, for a 5-V. meter. The 10-ma., 550-ohm shunts are obtained by moving the clips of a standard, 500-ohm size, bare-wire-wound resistor closer to the ends. The extra value of 50 ohms is readily obtainable.

The 10-A. shunt is a stock size for this meter. The 10-ma. shunts are connected in the plate leads between the socket selector switches. To make current readings on this scale with the test leads, it is necessary to set the socket-selector switches across one of these shunts.

Switch Sw.7, in Fig. 1, is in positive lead, and Sw.8 the negative. To measure plate voltage from the cable, Sw.7 should be set at P, or, according to the RMA socket numbering system

to 3, while the Sw.8 is set at K or H (or 7 or 8), depending on the type of tube. To measure plate current of the same tube, both switches should be set at P, the jack switches thrown to their proper position, and the correct scale selected.

Several dead points remain on the socket selector switches for future tubes, and on the scale selector for other scales.

All types of tubes may be tested in the analyzer, using the grid-shift method. For tubes with the grid at the socket pin, Sw.1 is thrown to "TEST." When the control-grid is at the top cap, Sw.2 is thrown to S.-G. (Toggle switch "NOR" on the panel is an "extra" for future use.)

The 5Z4 rectifier tube, having one different filament post, need cause no worry, because the cable feeds straight through, so that the filament posts in the set under test will occupy the same pins in the analyzer socket. To read the filament voltage of the 5Z4, set Sw.7 at 2, and Sw.8 at 8.

Current shunts are connected in leads 3 and 4. This may be extended to include all the leads, or toggle switches may be connected in several leads, and opened for current readings, the shunt then being connected to the scale-selector (Continued on page 488)

Fig. 1, below. The circuit of the free-reference-point unit.

Fig. 2, right. The analyzer volt-milliammeter unit.

Fig. 3, lower right. The adapters for permitting 4-, 5-, 6-, 7-, or octal-prong tubes to be tested and connected to the unit.

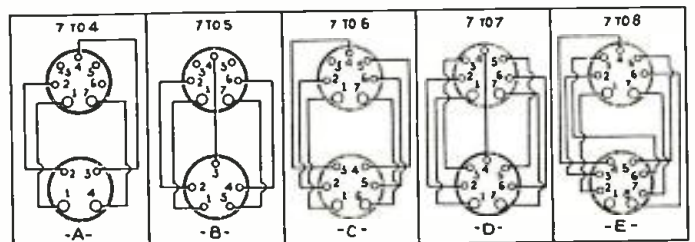
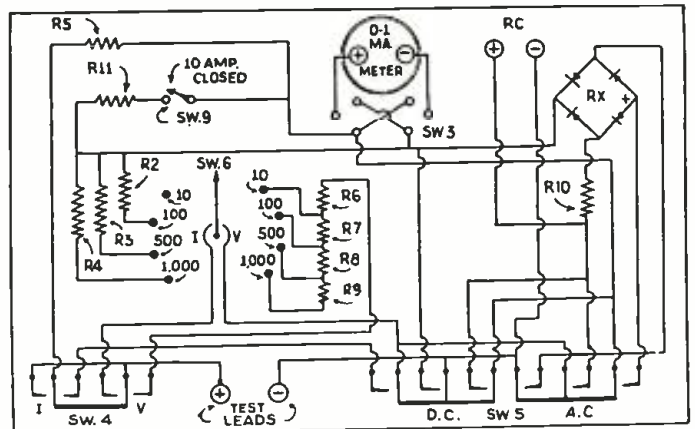
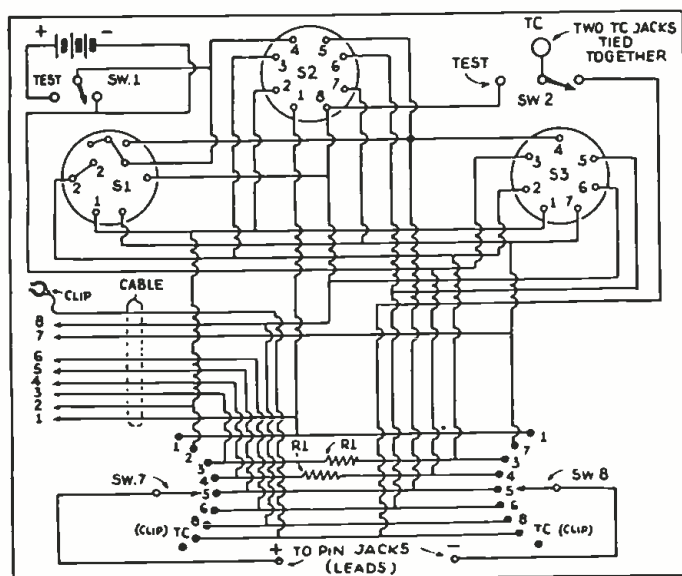

2 NEW METAL TUBES!

Here are two new additions to the metal-tube line. One is a (first metal multi-purpose!) "improved equivalent" of the 75 tube; the other is a full-fledged metal tube (it is a gas-filled filamentless rectifier), but glass-lined inside!

R. M. PURINTON

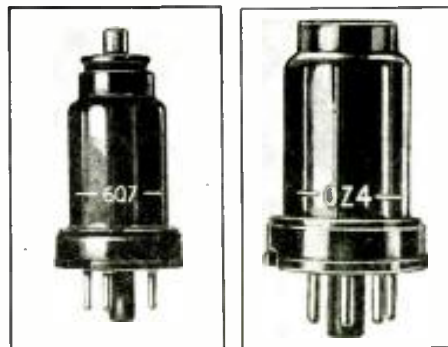

THE 6Q7 DUO-DIODE TRIODE

This tube has circuit applications corresponding to those used with the type 75 glass tube. Reference to the characteristics of the new 6Q7 shows noteworthy changes in the triode section. The amplification factor is 70 and the plate resistance 59,000 ohms—both lower than in the 75. The mutual conductance of the 6Q7 is slightly higher.

The result of these changes is a definite improvement in the signal-handling capability of the 6Q7. This tube is of the uni-potential cathode type; heater rating is 0.3-A. at 6.3V. Additional characteristics are as follows.

Triode-Section Class A Amplifier (Operating Conditions and Characteristics) (Shell tied to Cathode)

Plate voltage.....	250	100
Grid voltage.....	-3	-1.5
Amplification factor	70	67
Plate resistance, ohms	58,000	84,000
Mutual conductance, mmhos.	1,200	800
Plate current, ma.	1.2	0.4

(Continued on page 492)

Base connections of the 6Q7 and 0Z4.

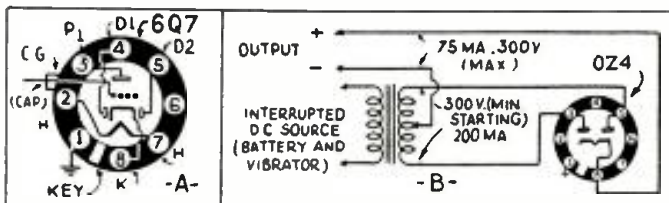

THE 0Z4 RECTIFIER

Since this tube operates through the ionization of a gas contained in a glass inner bulb, it does not require a filament. In basic principles the 0Z4 is closely related to the gas rectifier. (This is a type of tube which Raytheon pioneered in 1922, and continued developing to date; several exclusive patents on this gas-type rectifier are held.) The cathode of the new rectifier operates at an emitting temperature thus permitting values of rectifier efficiency and voltage drop comparable to those found in a mercury-vapor tube, equipped with a filament.

The 0Z4 was developed primarily for use in vibrator-type "B" supply units for automobile-radio receivers. It has the typical characteristics of all gas-filled rectifiers—as regards (a) a constant voltage drop; (b) ability to handle peak currents; and, (c) a tendency to generate R.F. noise. The R.F. noise (c) may be eliminated by proper filtering and by connecting the metal shell to the point giving the best shielding. The shielding (Continued on page 492)

The author compares the testing of metal and glass tubes in radio receivers.

TESTING METAL-TUBE SETS WITH PRESENT EQUIPMENT

F. L. SPRAYBERRY

MANY SERVICE MEN are of the opinion that the metal tubes are entirely different from their older glass cousins. Physically, there is a difference—electrically, however, the principle of operation is the same in both types. It is not absolutely necessary to purchase new test equipment in order to test receiver circuits using metal-type tubes.

Changes have been made, but they are not as radical as many believe.

The first thing that seems to worry

the Service Man is the fact that these new tubes have 8 prongs—one more than on any tube manufactured before. However, none of the new tubes have more elements than the former 7-prong tubes. The 8th prong is connected to the metal envelope of the tube. This is done to give the metal envelope a good ground so that it will act effectively as a shield.

A ground or chassis connection on an analyzer is very useful (we advocated it long before metal tubes were intro-

duced), and it has been provided in many analyzers.

Since the new tubes do not actually have any more elements than glass tubes, they may be tested in much the same way.

Of course, an adapter and additional sockets must be used to make connections between test equipment, tubes and the receiver. However, this will not present a serious difficulty if certain fundamentals are kept in mind.

(Continued on page 492)

Fig. 1. Circuit connections of the metal tubes and their adapters.

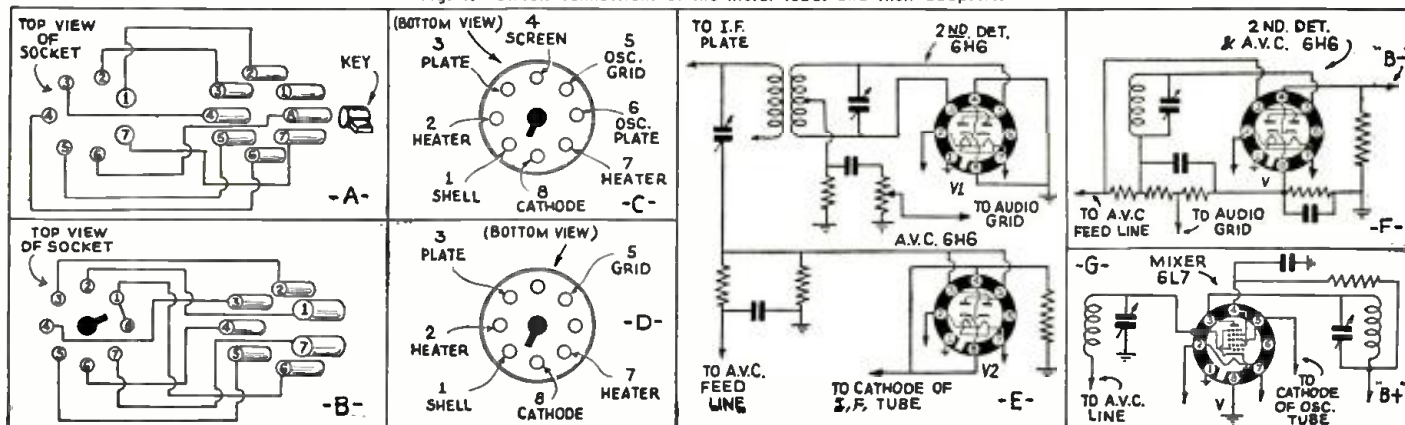

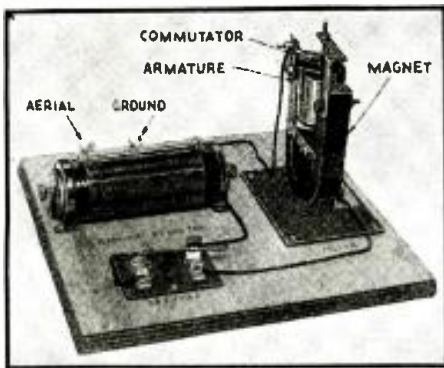

MAKE THIS "RADIO" MOTOR

This novel radio-operated device, shown for the first time at the New York Radio Show is easily constructed.

NATHAN I. HALL

The crystal-operated motor made for the N.Y. Show.

AN electric motor can be built using materials usually found in the radio fan's junk box which will run on radio power received from stations some miles away. The construction of the motor is not at all difficult and the average radio fan will find it both an interesting and instructive diversion from his usual radio activities. (This "motor," essentially, is a galvanometer provided with bearings and a commutator that allow continuous rotation in one direction.—*Editor*)

As might be expected, such a motor cannot be used to drive any mechanism as all of the power developed is used in overcoming friction in the motor itself. The motor built by the writer will run on an input of one ten-millionth of a watt (armature current 7 microamperes and armature resistance 2,000 ohms) and can be truthfully called a "flea-power motor."

The major parts necessary for its construction are: a crystal receiver, a horseshoe magnet, a short piece of iron rod and some small enameled wire from an A.F. transformer secondary or a Ford coil secondary.

As this motor operates on D.C. only, the purpose of the crystal receiver is to tune in the desired station and to change the R.F. current induced in the antenna into D.C.

A signal loud enough to be easily heard will be sufficient to operate the motor.

It is necessary that the current through the armature winding be reversed at the end of each half-revolution of the motor. On weak signals this must be done with a hand switch but on powerful signals it may be accomplished with a mercury or metal-segment commutator.

Figure 1A shows top and (Continued on page 488)

Fig. 1. Details of the motor which will enable anyone to construct one from parts found in the junk box.

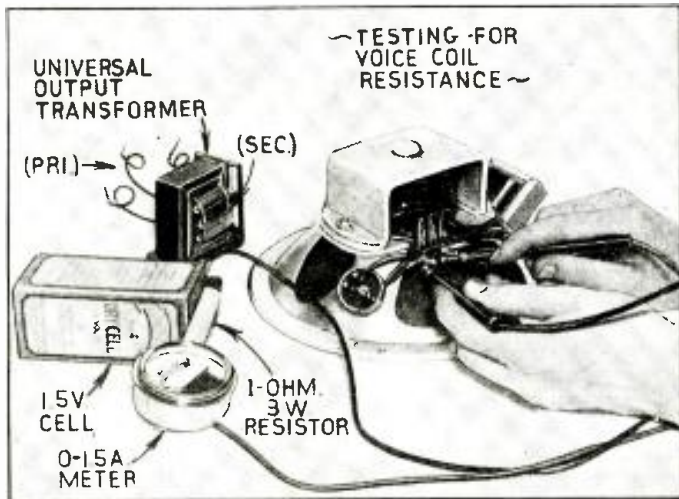
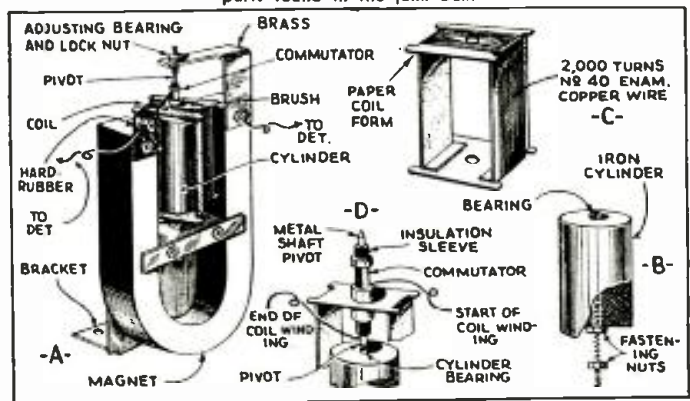

Testing voice-coil resistance for impedance matching.

THERE is on the market a "universal output" transformer so designed that it enables the Service Man to service a large number of radio sets with a single unit in the event of output transformer failure. Original performance is restored, and in some cases better than original performance is obtained.

The novel feature of the transformer is that although the primary is untapped, it matches almost any single tube or push-pull output stage. For push-pull operation, correct primary matching is obtained when 71A, 45, 50, or 43 type tubes are used. For single tube output using the total primary, correct matching will be obtained with the 33, 47, 41, 42, or 2A5 tubes. One-half of the primary can be used to match to a single 48 tube.

Various secondary matching impedances are obtained by a tapped secondary. The taps are arranged to accomplish the most uniform variation of impedances with a

A NOVEL SELF-MATCHING OUTPUT TRANSFORMER

Description of a novel transformer that is matched to universal outputs by means of secondary taps, used in combination.

C. E. DeHORN

minimum number of terminals. The range of load impedances is from 1 to 30 ohms. The various load impedances and their respective terminal connections are given below:

Impedance (ohms)	Terminal numbers	Impedance (ohms)	Terminal numbers
1	4-5	14	2-4
2	4-6	16	1-4
3	3-4 or 2-3	22	2-5
4	1-3	25	1-5
8	3-5	28	2-6
12	3-6	30	1-6

Two other terminal combinations are possible but load impedances for these combina- (Continued on page 488)

The circuit of the transformer, left, and low-resistance ohmmeter, right.

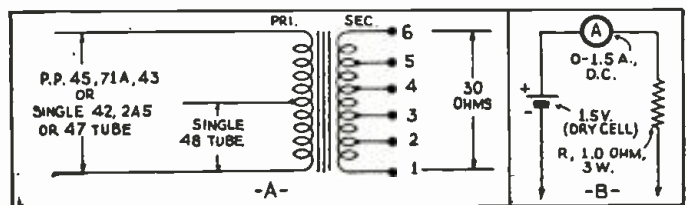

A department in which the reader may exchange thoughts and ideas with other readers of RADIO-CRAFT.

READERS' DEPARTMENT

AMERICAN SET MAKERS PLEASE NOTE!

London, W1, England:

Some time ago I purchased from a radio dealer in London (England), a "Belmont" radio set and took it out to India. It worked splendidly for about six weeks, picking up most of the Continental stations, but then it developed faults—probably the insulation broke down—which could not be located. My dealer supplied no address of the manufacturer or its London agent, but I was able to ascertain the Chicago address and wrote accordingly—but no reply ever came. So the set was practically useless and no assistance could be obtained from the dealer.

I am in London, again looking over several portable American sets. There are several—such as "Sparton," "Kylectron"—but my difficulty, after previous experience, is the same—the dealers are unwilling to disclose the agents' or manufacturers' addresses, and no technical data, drawings or information are available on these sets. My personal experience of American manufacturers is that their products are above suspicion and so are their business dealings, and the only conclusion I can draw is that small dealers here, in order to obtain perhaps high percentage of profits and, fearing one might write directly to America, are adopting such practices. It would, I feel, be a greater advantage to American manufacturers if they issued their names and addresses together with those of their local agents with necessary technical details, which would create confidence in the purchase of their sets, as it is admitted here that in small portable radio sets no country in the world can compete with the U.S.A. (*Thank you, Mr. Nissar.*)

Perhaps it may be of equal interest to the manufacturers of "Kylectron" sets if I state my experience that for inquiry of their sets I called at the "Radio Center," 53/54 Haymarket, London, S.W./1, an agency which is always too willing to assist and advise on matters relating to radio sets, and they gave me to understand that some one left a "Kylectron" set with them for demonstration, but they were unable to either trace the dealer or determine to whom to return the set nor had they any technical information on hand that would enable them to give any views on the set.

American enterprise in advertisement is par excellence but this takes the cake in lack of proper advertisement.

I am calling the attention of the American Chamber of Commerce here and would also appreciate your courtesy if you can recommend to me a small 5 or 6 valve (tube) portable set (the best on the market), and also ask the makers to send me details, as I would prefer to purchase directly from the States.

Is there any publication in the U.S.A. that will give full particulars on portable American sets or their parts to make up or assemble at home? Your journal does not supply necessary information on this matter.

A. R. NISSAR,
% Thomas Cook & Son,
Berkeley St.

Here, indeed, is an interesting expression of personal experiences, and one which it would be well for the manufacturer with an eye to business expansion abroad to give consideration.

There are no publications that furnish construction details for the home construction of factory-built sets, but there are several magazines, including *Radio-Craft*, that publish complete details, including an itemized List of Parts, for building up radio receivers of all sorts and kinds, from "1 tube-ers" to 10 and 12 tube jobs that do everything but wash and dry the dishes. However, unlike some of the English magazines, for instance, which devote a

large portion of their editorial space to the construction of kit sets, American radio magazines seldom describe, in a single issue, the building of more than 2 or 3 radio sets of assorted types, since space must also be available for describing public address amplifiers, test equipment of all kinds, etc. (Except for imported units, tube checkers and set analyzers are an almost unknown quantity in Europe—it is probable that the lack of standardization in tube characteristics, prong and socket connections, etc., are factors that deter even the most adventurous of manufacturers.) Several of the American "trade" magazines carry advertisements by the foremost set makers, and the editorial columns of these publications include illustrations and reviews of the outstanding features of all makes of radio receivers. The more outstanding designs are discussed, in the *Radio-Craft* "Data Sheets."

A NEW RACKET?

Long Beach, Calif.:

You have had many fine articles on the design and construction of P.A. equipment. Also articles on getting business along this line.

However, I have yet to see any mention of "The Authors & Composers Association." Personally I feel this is one of the biggest rackets in the radio-P.A. line. I know that all the radio and P.A. men in this district of California feel as I do on this matter, and I believe that you will find the feeling is the same wherever you go.

What is this association and what right have they to charge us to play popular music on our systems? Don't we pay for the records and sheet music and does not the price we pay include the royalties and cuts for making the records and composing the music? Why then, in order to play records or radio, or to pick up an orchestra playing popular music with our microphones, do we have to pay an additional royalty of \$7.50 per day for a portable amplifier or \$300.00 per year for a permanent installation? Haven't the artists or composers already gotten their cut on every record or piece of sheet music?

If the fee was \$1.00 or \$2.00 a day instead of \$7.50, I believe that Service Men would pay and say nothing, even if they felt it was an imposition. I do know that there are many Service Men (*Continued on page 489*)



The noted comedian, Milton Berle, had a seat away on the outskirts of the Baer-Louis fight where he could neither see nor hear the progress of the great battle, so he equipped himself with a small portable set and enjoyed the fight! (We wonder, therefore, whether this "Berled" his neighbors!)

INTERNATIONAL RADIO REVIEW

RADIO-CRAFT receives hundreds of magazines from all parts of the world. Since the cost of subscribing to each of these would be prohibitive for most radio men, we have arranged with technical translators to prepare reviews for our readers.

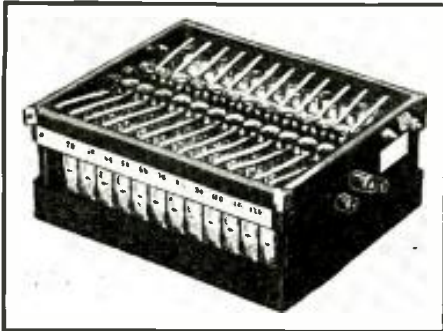

Fig. A. An alkaline "B" unit popular in Australia.

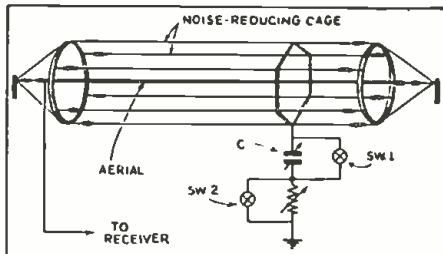

Fig. 1. An experimental aerial for reducing noise.



Fig. B. A radio table of English design.

Fig. C. A tuning dial like the automatic phone.



A NEW ALKALINE "B" BATTERY

THE percentage of "rural" (battery-operated) sets in Australia is quite high, as many of the outlying towns have small power plants which cannot be depended upon for radio receiver power supply because of the wide variations in supply voltage with varying loads. Also, many of the sets in use are located on farms and ranches where no electric power is available.

Thus, batteries are still a very important item in radio reception "down and under."

Radio Review of Australia (Sydney) recently printed a description of a new "B" battery of the nickel-cadmium type, similar to the Edison battery. This unit contains small cells arranged in groups of 4, which, in conjunction with a unique built-in switching arrangement changes the wiring from a straight-forward series circuit to a series-parallel unit having 4 cells in each series group (see Fig. A). By this system, the battery can be charged from any 6 V. battery charger, wind-driven generator or similar arrangement.

NOISE-FREE ANTENNA

AERIAL systems designed to reduce the annoyances of man-made static have been sold, now, for some time—since the advent of the all-wave receiver. Various types, each having certain advantages, have been made.

Another type, different in mechanical construction from the types available in the U.S. was described in *Radio Magazine* (Paris) recently. As shown in Fig. 1, it consists of a wire about 30 ft. long suspended between insulators and completely surrounded by a cage aerial, slightly shorter than the single wire and completely insulated from it.

The cage is grounded through a condenser of 500 mmf. maximum capacity and a variable resistor of 5,000 ohms which are connected in series and each equipped with a shorting switch.

By correct adjustment of the resistor and condenser, it is claimed that local man-made static noises can be completely eliminated by the shielding effect and (Continued on page 489)

Fig. D. A receiver disguised as a group of books for use on a library table.

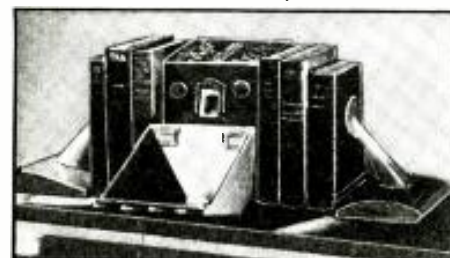

Fig. E. A hi-fidelity set of German design.

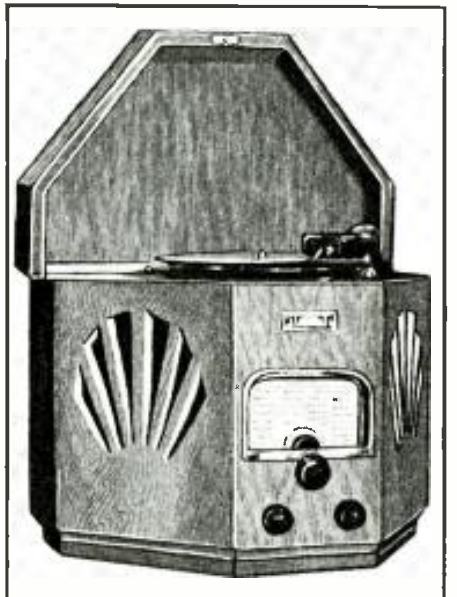

Fig. F. A hexagonal-shaped radio-phonograph cabinet.

Fig. G. A cylindrical-shaped radio and automatic phonograph turntable and pickup.



WAR-TIME USES OF RADIO

Radio is now used in all branches of warfare; but then, "wireless" communication was essential even in 1184 B.C.!

E. W. SLOPE

ETHIOPIA and Italy at war present factors of greater political and economical importance, and more tactical interest than any that have arisen in other conflicts within the last 30 years. A highly modernized army, equipped with all the devices science can provide, fights against an enemy army which is (despite the fact that some modern weapons are available to the Ethiopians) of ancient organization. Our interest in this struggle is not only in the strategical value of the application of modern machine guns, airplanes and tanks in a country of wilderness, but in the test of the communication system utilized in this war.

It is an old strategical axiom that "an army is as good as its communication system," and tactical dogma that "an army without a properly functioning communication system has about the same value as a chain with some disconnected links." What may be the nature of the communication system does not matter as long as it fulfils its purpose, and effectively parallels the system utilized by the enemy.

"WIRELESS TELEGRAPHY" IN THE YEAR 1184 B.C.!

The efficacy attained with an old-fashion communication system in war-time is described by Aeschylus, in his famous "Agamemnon" (verses 274-309), in which he reports how the Greeks (in the year 1184 B.C.) after their victory over Troy, in Asia Minor, telegraphed their jubilant message to

Greece in a surprisingly short time, by means of 9 relay fires kindled at the tops of high mountains, and bridging by this first-known example of "wireless telegraphy" in history, a distance of about 320 miles.

In more recent times, the importance to victory, of a well-functioning communication system, was impressively demonstrated in 1914, by the famous Marne victory of General Joffre over the Germans. This victory was made possible not only because the Germans had over extended themselves and had also a defective transportation system, but due also to their communication system which at this time did not function efficiently. The Ethiopians try to copy General Joffre's tactics, permitting the Italians (as did Joffre) to occupy important points, even going so far as to cut the unique Djibuti-Addis Ababa railway. But it seems the Italians also have learned from the Marne battle and are careful not to be strung out without immediately setting up an extensive communication network, which in November, 1935, saved them from defeat in northern Ethiopia.

"SWS" AN ENGLISH SECRET

Still other World War battles were won—and lost, via the communication-system route. The great North Sea battle off Dogger Bank started, to the dismay of the Germans, by the interception of important messages. As a result of messages picked up by the secret "SWS interception stations" on the east coast of England, the German High Sea Fleet (*Continued on page 490*)

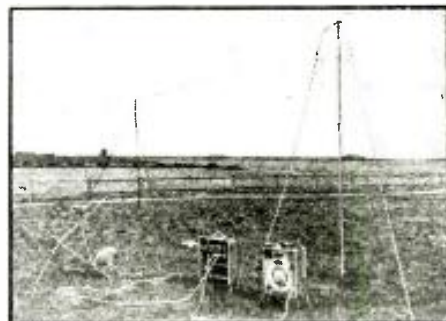

Pedal-powered 1 W. portable station which may be used for fone or C.W. work. This German field radio is depicted ready for operation.



U.S. Coast Guard planes equipped with a loop antenna enclosed in a bakelite "egg" gain 5 m.p.h. more speed!



Two-way radio equipment in the cockpit of a U.S.A. Curtis Raven light bomber. Note that the apparatus is entirely covered.

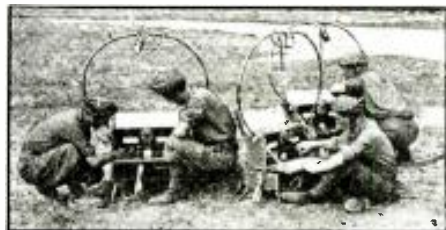

Radio operators of the Italian Army in action. These sets are of the loop type and the batteries are in the lower boxes.

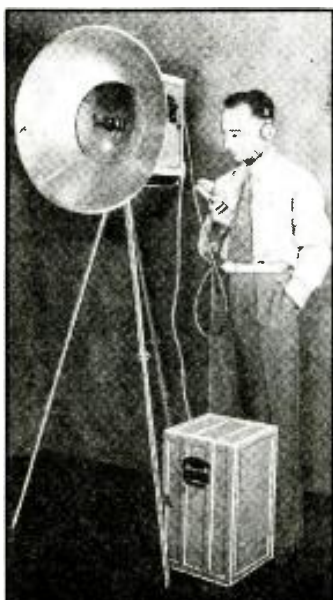

Newest British "pocket" submarine (extreme left); note radio antenna.

Left, another "mystery ray" machine which has its power supply in the large box (which is the carrying case for this entire, demounted German "station").

Right, newest English tank; note aerial. The set works on 9.23 meters with 2 W. power.



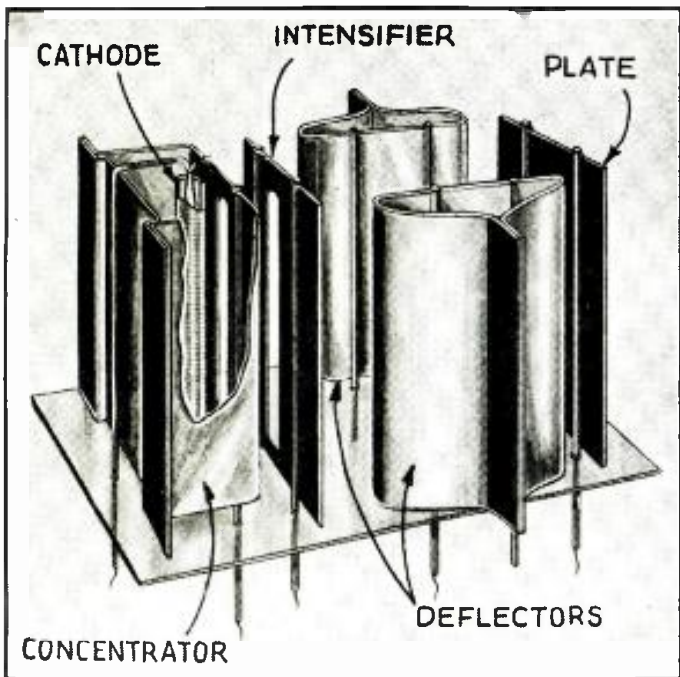

THE RENODE— A NEW GRIDLESS TUBE

A revolutionary Danish radio receiving tube of "cathode-ray" type is announced in this exclusive story by our Danish correspondent.

SVEND ANKER-RASMUSSEN

Fig. A. The internal structure of the tube showing the cathode surrounded by a shield having a slot cut parallel to its axis; an "intensifier" to speed up the electrons; two "deflectors" to control the electron stream; and a plate.

CONTROLLING THE BEAM

Now, if the numerical value of the concentrator potential is *decreased* (as indicated by [- -], in Fig. 1C), the beam will spread itself out in the middle between the deflectors. A further decrease of the concentrator potential ([-], in Fig. 1D) will result in some of the electrons touching the deflectors, which are thus compelled to receive a certain number of electrons.

When the value of concentrator potential required to bring the tube functions into the state illustrated at Fig. 1D is found, the goal of "ordering the cathode ray" to suit a purpose has been reached. If R.F. currents are now applied to the deflectors, as shown in Fig. 2A, the beam will be deflected alternately towards either of the opposite deflector elec- (Continued on page 493)

FIRST PUBLISHED DESCRIPTION!

In this exclusive article RADIO-CRAFT presents the first description in America of the radically new cathode-ray type of detector, amplifier and oscillator tube. According to available data it apparently results in more selective, sensitive, and noiseless performance than present grid-type tubes! It appears to rank in importance with the recently-announced (Jan. 1936 issue) Zworykin electron-multiplier "ray"-type tube.

GRIDLESS vacuum tubes, in a new series, have just been introduced in Denmark! Due to a peculiar patent set-up, Denmark has been subjected to excessive licensing fees, and it is this situation which the new tubes have been designed to circumvent.

The following technical and political explanation outlines the characteristics and conditions under which the *Renode*, as the new tube is called, has been introduced.

OPERATES ON CATHODE-RAY PRINCIPLE

In principle, the Renode has some resemblance to the *Braun* tube, the workings of the former being founded upon deflection of cathode rays (first utilized in the latter).

The interior arrangement of the electrodes in the Renode is shown in Fig. 1A. The circle indicates a cross-section view of heater; and cathode, K. Element C is a metal screen or shield (hereinafter called the *concentrator*); it surrounds the cathode, and has a slit across it parallel with the length of the filament. Electrode I is an auxiliary plate termed the *intensifier*; it is plate-shaped and has in the middle of it a slot of exactly the same size and position as the one in the cathode screen. Plates D1 and D2 are called *deflectors*. The ordinary *plate* or "anode" is identified as P.

Now let us proceed to see how this arrangement works, by referring to Fig. 1B. Potentials are applied to the electrodes as shown; cathode, and deflecting electrodes D1 and 2 are at zero voltage; the intensifier, I, and ordinary plate, P, under a certain positive potential; and the concentrator, C, at a suitable negative potential (as indicated by [- - -]).

Under such conditions a concentrated, straight-line electron beam, the outlines of which are defined by the apertures of the concentrator and intensifier electrodes, will flow across to plate.

Fig. B. The appearance of the tube elements.

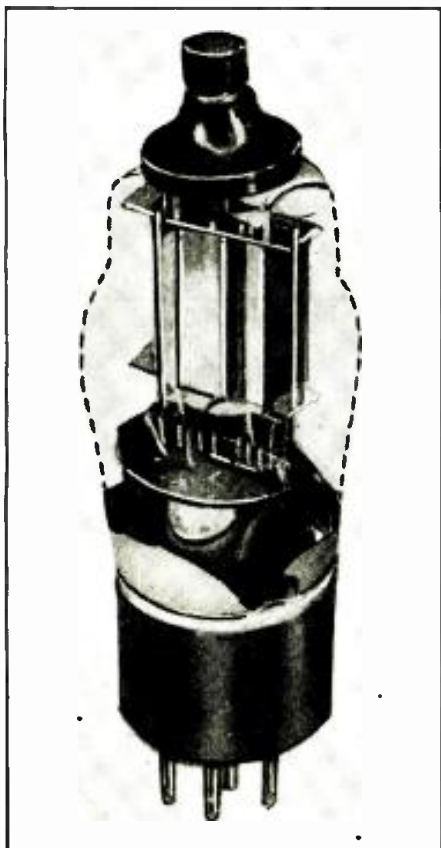

Fig. 1. The tube action in detail.

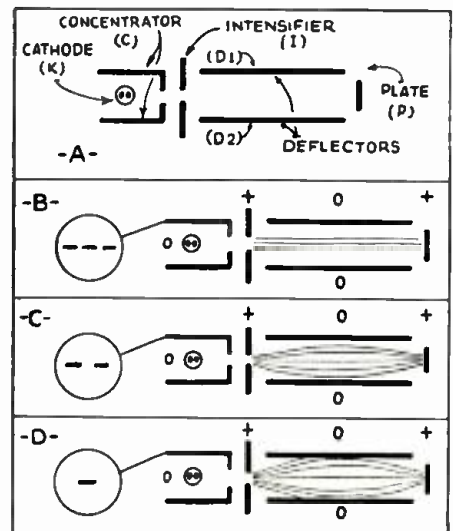
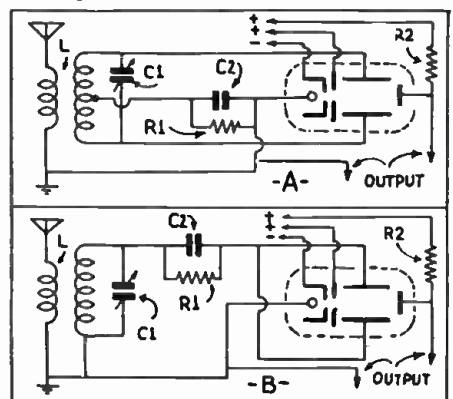
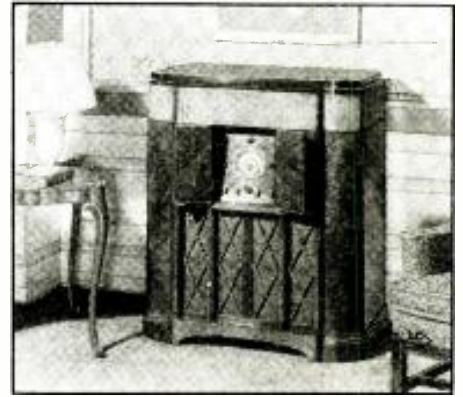

Fig. 2. The circuit for detector action.



NEW DEVELOPMENTS IN ALL-WAVE RECEIVER DESIGN

With the number of tubes in some of the new sets running to 20 and more, users wonder if all of them are needed.



THE NEWEST all-wave sets are becoming more and more complicated with each succeeding model, until the long-suffering consumer begins to wonder if he couldn't get along just as well with a lot fewer tubes. We shall try to explain herein some of the uses of this multiplicity of tubes as well as some of the other complications of one example of the latest in phono-radio combinations.

In the first place, the general trend at present seems to be toward the coverage of a wider band of frequencies, in order to include more of the interesting types of transmission on the air. The set illustrated diagrammatically below has a range of 140 to 410 kc. and 540 to 60,000 kc., the space being left, as usual, because of the I.F. amplifier which is tuned to 460 kc. (at which

I.F. an R.F. "dead spot" is produced).

The use of metal tubes is becoming more widespread all the time, and despite arguments of the relative worth of metal and glass tubes, the fact remains that there are several entirely new types in the metal line which have been found exceptionally useful and efficient. One of these is the 6L7, 2 of which are used in the circuit below; one as a 1st-detector or converter, and the other as an "expander" tube, which latter will later be explained in more detail.

The 6E5 cathode-ray tuning tube naturally cannot be made of metal since the tuning indication must be viewed on the elements of the tube. It is one of the latest types though and counts as "1" in the surprisingly high total of 22 tubes!

The use of a separate A.V.C. amplifier and rectifier tube is quite widespread nowadays. At first glance this seems to be merely another method used to swell the already large number of tubes. However, the use of these separate tubes provides a much better control of output than if the A.V.C. duty was loaded onto the 2nd-detector.

The push-pull audio stages are used to obtain greater power and better tone quality than would be the case if single-tube stages were used. The output stage of the circuit pictured is rated at 25 W. While this is away above that needed for the average use, it insures that when a loud low note comes through, there will be sufficient power to reproduce it without distortion.

The output of 25 W. may not be needed so (Continued on page 505)

Fig. 1. Circuit of one of the newest all-wave radio-phonograph set—the RCA model D 22-1. The phono. section includes an "expander" in its amplifier.

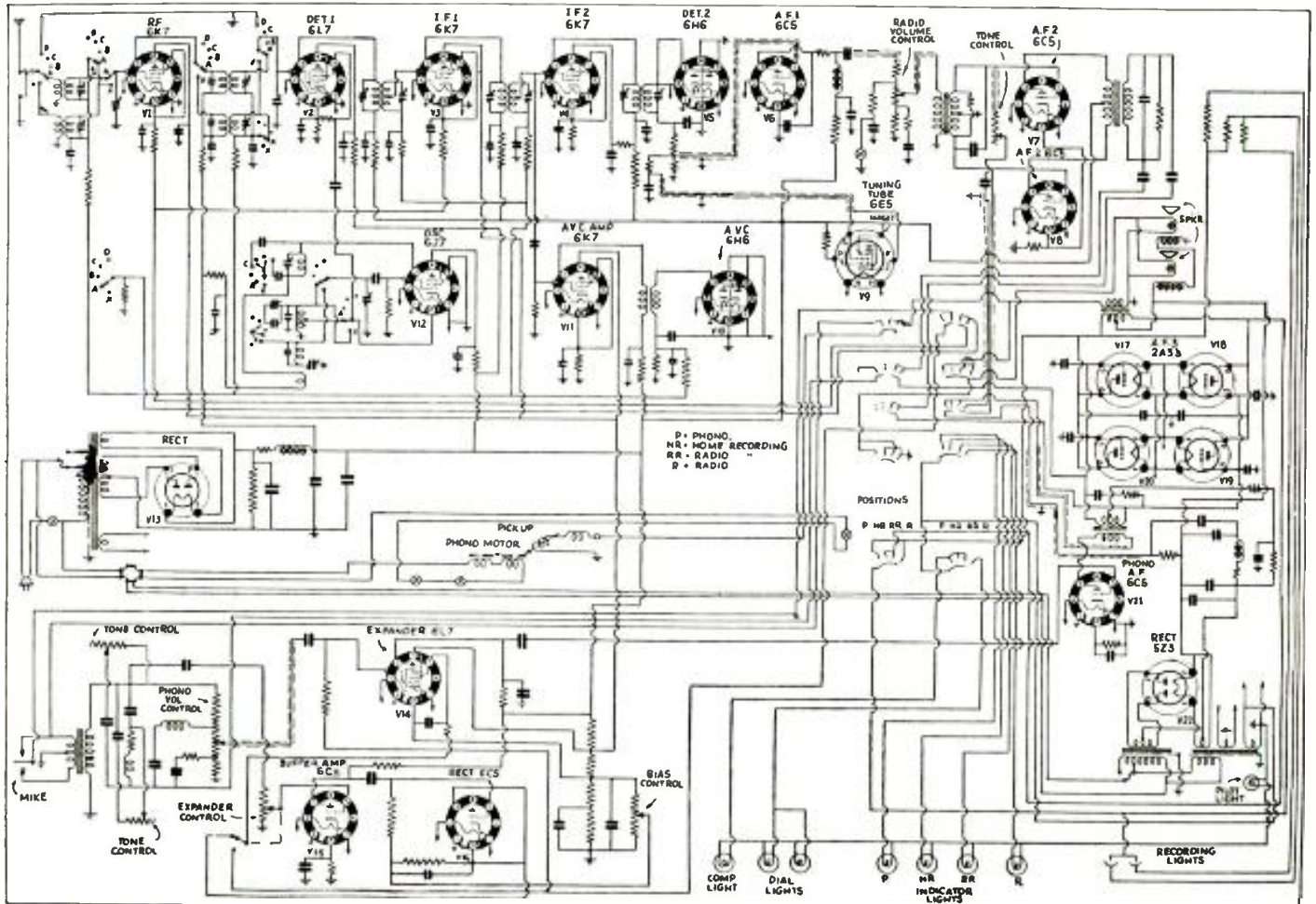
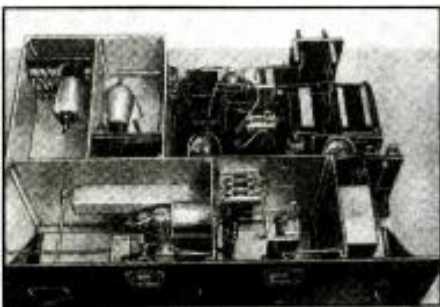



Fig. B, above. Von Ardenne with the deluxe set.
Fig. A, below. An inexpensive television set.



NEW GERMAN TELEVISION RECEIVERS

Two new television receivers are described—one a reasonably priced instrument and the other a super-set.

MANFRED VON ARDENNE

TELEVISION technique is now 50 years old—therefore, it is much older than even the earliest types of radio telegraphy, not to mention radio broadcast transmission. Still, despite its antiquity the technical development of television is still far from its final goal. Each month brings tremendous strides towards perfection of image reception. Today, the drawing board and pencil are tools that permit the research laboratory worker to present a graphical fixation of his ideas much more rapidly than can a corps of dexterous artisans convert the ideas born in the laboratory into devices for practical application.

An impressive demonstration of the progress in German television technique was given at the recent Berlin Radio Show. One of the displays included the inexpensive television receiver shown in Fig. A. This model, developed in my laboratory, is produced in a series of small models by the firm of C. Lorenz, A. G.

A television receiver having much greater dramatic appeal is shown in Fig. B. This set was designed according to my own latest ideas, and was built by C. Lorenz solely on a quality basis—that is, without regard to cost, just to show what could be done, and also to point (Continued on page 505)

Fig. C. The wide-range amplifier discussed.

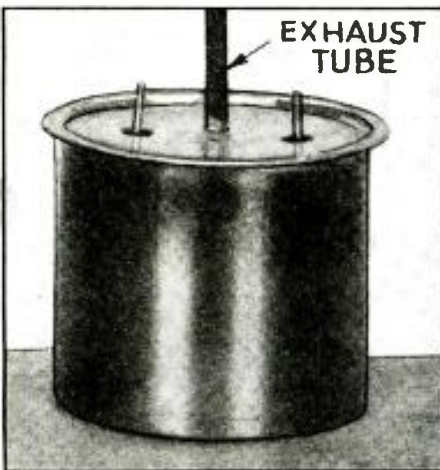
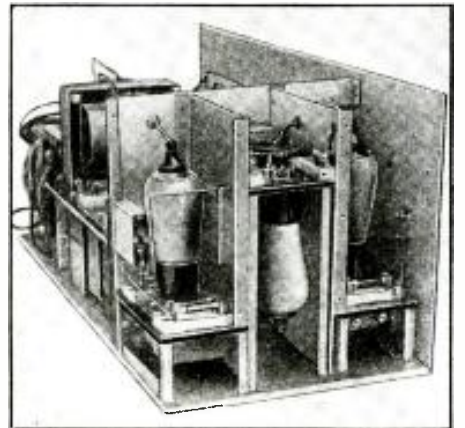

Fig. A, G.E. (experimental) metal tube No. 11

OUTSTANDING MERITS OF METAL TUBES

A comparison of the dimensions and operating characteristics of glass and metal tubes.

HERBERT M. NEUSTADT

that the metal tube is much shorter than the glass tube. In Fig. C it can be seen that the smaller size of the metal tube is not due to any reduction in the size of the electrodes. The all-

metal tube, as a package, contains just as much vacuum tube but wraps it up with less waste space.

The compact structure of the all-metal tubes (Continued on page 503)

Fig. B. Tube-size comparison. Fig. C. Comparison of elements. Fig. D. Comparison of leads.

NOW THAT the all-metal tubes are in everyday use, it is becoming more and more evident that they have several outstanding merits. These merits seem increasingly important as set designers and Service Men continue to acquire experience in working with these tubes.

In the first place, all-metal tubes are compact. Small size is one of the qualities that impresses you immediately when you inspect an all-metal tube. It is mainly because of this small size and because they require no shield cans that some of the new sets are so compact. This compactness of the all-metal tubes is illustrated in Figs. B and C where a 6K7 is compared with its corresponding glass tube. You can see in Fig. B

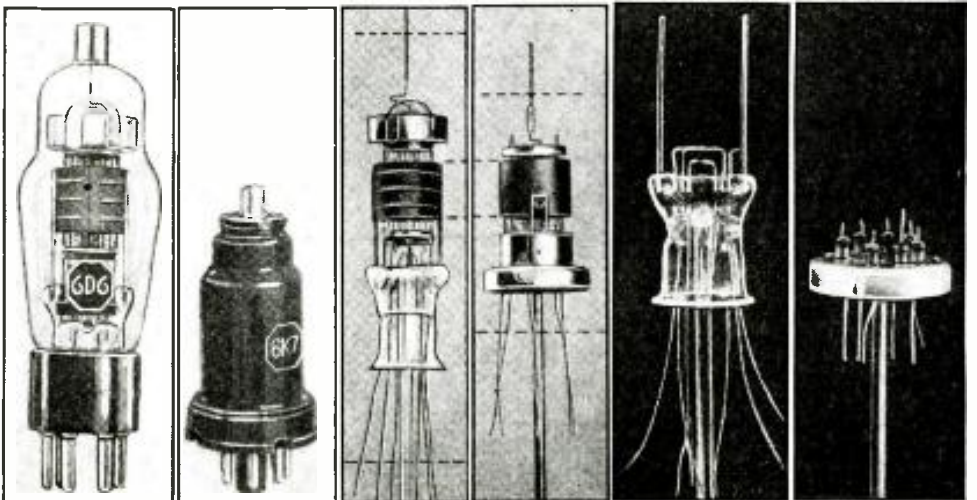

ANALYSES of RADIO RECEIVER SYMPTOMS OPERATING NOTES

LYRIC MODEL S-8

THE customer complained of noisy reception saying that the set would sometimes play well for 5 minutes or so then go noisy again. A shorted condenser, C1, Fig. 1A, was found and replaced but the noise continued. Finally the A.F. input transformer was replaced and this cured the trouble. This transformer had checked OK on a resistance test.

CROSLEY MODEL 102 AUTO RADIO

WHEN circuit oscillates and loads up, test the 6B7 second-detector tube, which will usually be found to have low emission.

When this same set goes entirely dead, the 0.1-mf. condenser across the power transformer secondary, Fig. 1B, will often be found shorted.

J. H. PARKER

GENERAL ELECTRIC K-64

ON EVERY General Electric model K-64 radio receiver we have received, we have had the trouble of reception cutting off and on as the tuning dial was rotated. As soon as the chassis was removed from the cabinet, the trouble would correct itself.

We have found the cause to lie in a bare wire that connects the stator plates of the condenser gang to the wave-band switch, and which runs close to another bare and grounded wire. The condenser gang is movable, inasmuch as it rests on rubber cushions. Now, when the chassis is inserted in the cabinet, downward pressure is put on the condenser by way of the shaft that protrudes through the hole in the cabinet and which rubs against the upper side of it. This forces the two wires very close together and the least movement of the condenser gang will short them entirely. To correct this trouble, simply separate the wires about twice the distance they were originally.

GENERAL ELECTRIC K-52 AND K-53

WE HAVE been called to service several General Electric models K-52 and K-53 radio receivers in which there was considerable hum present. The receivers were operating without a ground connection, and the simple procedure of affixing a ground stopped the hum, whereas other methods had failed.

A.C.-D.C. SETS

IN THE small universal A.C.-D.C. radio sets of several different makes we have increased the sensitivity by taking a short piece of wire (insulated) and attaching it to the stator plates of one section of the condenser gang and making about 4 or 5 turns about the wire leading to the second-section stator plates.

JAMES G. SHELLER, JR.

ATWATER KENT MODEL 45

TROUBLE: volume very weak. Cause: no detector plate voltage. Effect: detector plate voltage dropping resistor in power pack was found to be open. Inspection of the resistor disclosed a loose metal cap at one end. (This

particular resistor is constructed of a carbon element enclosed in a glass tube with metal caps at each end sealed with solder.) By heating the loose cap with a soldering iron, the old solder was cleaned out and fresh solder applied to re-seal the cap.

The repaired resistor showed no change in value when tested and when placed back in the power pack, the receiver was restored to full volume.

WM. PAUL SPORKA

PHILCO AUTO SET

THIS set was installed in a Dodge car and the complaint was intermittent operation. The trouble seemed to indicate a bad tube but upon checking them, none was found defective. A hard jar would cause the radio to play temporarily. All parts checked perfectly and no loose wires could be found. Eventually the trouble was found in the I.F. coil. Two small nuts on the top were slightly loose, and when tightened the set gave no further trouble.

GAROLD F. SHEPHERD

PHILCO MIDGET

I HAVE often found when servicing this receiver that the 75 tube is microphonic. These tubes usually test OK in a tube tester, but when the receiver is jarred or struck sharply, noises are most often traced to this source.

RCA-VICTOR R-17

BY REPLACING the .004-mf. condenser, connected across the primary of the output or speaker transformer, with a .01-mf. condenser of the tubular variety, the tone quality is greatly improved.

EMERSON "MICKEY MOUSE" MODEL

THIS receiver is a very small compact midget that sometimes develops an annoying hum when in service for a short time. This hum can be greatly reduced, if not entirely eliminated, by connecting a condenser of high capacity between one side of the line and the chassis. Another method to reduce this hum is by changing the position of the 100 mmf. coupling condenser. The best position for this condenser can only be ascertained while the receiver is in operation.

RICHARD B. GRAF

CROSLEY 58

COMPLAINT: Switch had to be thrown a half-dozen times before set would play, although tubes and pilot would light. With the "innards" exposed, the placing of the test prods on any part of the "B" voltage system would start the set.

All condensers and resistors, on a separate test, showed OK. I then placed the voltmeter across each condenser with the set off, and then snapped it on. After a few trials, the trouble was found in the condenser bypassing the detector grid-bias resistor. This condenser was shorted but the least change of voltage would clear it up.

MAJESTIC 70

THIS set would play for about 5 minutes and then die away. A snap of the switch, off and on again, would bring the signal back again but it would die out in about a minute. After a great deal of "fussin' around" the fault was located in the filament winding of the type 26 tubes. The voltage would show 1.8 V. when first turned on, then would gradually drop to 0.5-V.

MAJESTIC 130-A

OSCILLATION from 900 kc. to 550 kc. Balancing did no good; voltages were OK; condensers tested OK. Poking among the wires in the bottom of the set, I moved the ground lead of the .04-mf. condenser in the grid circuit of the first R.F. tube and noticed a change in the pitch of the oscillation. I disconnected the lead and the oscillation disappeared. A new condenser was tried and the oscillation returned. After trying a couple more with no better results, I returned the set, minus the condensers. Calling around a few days later, I was informed that the set worked better than ever before. (The writer has no explanation to offer for the cause of this fault, or its cure.)

SILVER-MARSHALL MODEL A

THIS set was found with 3 resistors so changed in value that the voltages were all "haywire." Replacement cleared this up but the receiver didn't have the kick a set of this type should have. A study of the diagram revealed an 0.1-mf. condenser across the 47-tube bias resistor. I tried a 10-mf., 25 V. electrolytic condenser across this resistor and the volume increased considerably, and the tone quality was improved.

SILVERTONE 117 AND COLONIAL 36 A.C.

THESE sets have the same circuit and chassis. In table cabinets the dial must be turned to the arrow before the chassis can be removed from the cabinet.

RADIOLA 60

IF THIS set acts as though the variable condensers were shorting to each other, examine the pilot light bracket. It may have dropped down against the drum dial.

JAMES J. WALTERS

CHAMPIONETTE 5-TUBE MIDGET

THE receiver, after being turned on, would bring in a station as soon as the tubes were warmed up and then would fade away completely and remain "dead." All voltages checked OK except that of the detector tube screen-grid, which read 150 V. (a value which was too high). Everything else checked OK so I measured the carbon resistor which is connected between the high-voltage lead and the screen-grid of the detector tube. This resistor, which according to the color code should have been 25,000 ohms measured only 8,000 ohms. Upon replacing that resistor with a new one of 25,000 ohms, the radio set worked normally.

(Continued on page 487)

Fig. 1A. Noisy reception in a Lyric S-8.

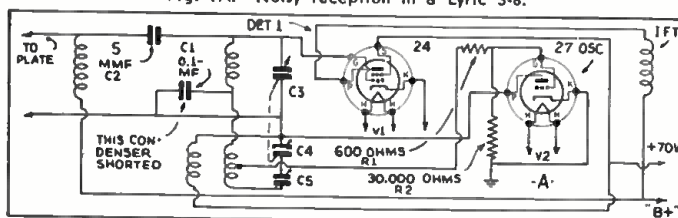
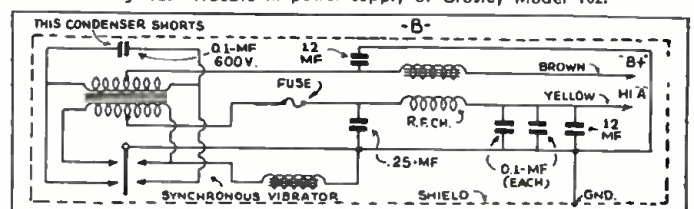

Fig. 1B. Trouble in power supply of Crosley Model 102.





Soundproof box containing the record changer.



"Master control" box located in owner's room.



One of the many loudspeaker installations.

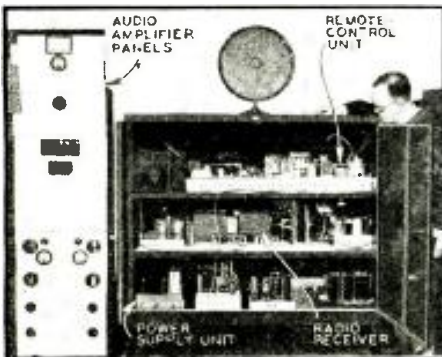

The actual apparatus installation.

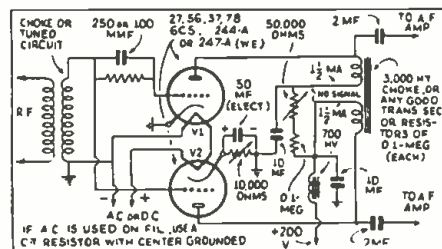

A \$30,000 "RADIO" INSTALLATION

First published description, exclusive to Radio-Craft, of a millionaire's "radio" system containing features of interest to the home constructor; uses Hiler-patent A.F. system.

RUSSELL D. LANNING

SEVERAL years ago the writer was first called in by a millionaire in upstate New York to install a "radio" system that would be the finest available in reproducing radio and phonograph programs. Continuous development from this starting point has resulted in the superlative installation here illustrated and described for the first time in any publication.

Costing over \$30,000, to date, the system incorporates many new and novel features, some of which are patented. Many of these interesting items are here highlighted as being of interest not only to the technician but also to other home owners appreciative of unusually good voice and music reproduction, and of equipment installed in a manner as befits a luxuriously-appointed home.

The installation pictured here uses as many as 8 speakers in one room! Each reproducer placement is equipped with speakers designed for a special band of frequencies and with an adjustable filter network in each voice coil, as shown in Fig. 1. In the library, two speakers are designed for covering the frequency range from 30 to 400 cycles, two from 200 to 1,500, two from 200 to 3,500, and two tweeters from 2,000 cycles to the upper limits of present-day reception.

Although the sound system is superb, the method of control is still more novel and about the neatest system ever conceived.

A FINE REMOTE-CONTROL SYSTEM

Each master control box is equipped with a gold telephone dial, a station-registering dial calibrated in kilocycles, 2 pilot lights, phonograph switch, record-reject button, on-off switch for A.V.C., radio set volume control, phono. volume control, manual tuning key, master lock-out switch, speaker mute and on-off switch.

Any one of several favorite pre-tuned stations is selected by a flick of the dial

(each hole in the dial corresponding to a station). At the instant of moving the dial, the reproducers are silenced, a red pilot glows, and when the station is tuned-in the light goes out and sound is heard. The method of driving the radio tuner is so precise that pre-selected stations tune to resonance on a tuning meter from either direction, and because of the fact that all master boxes are equipped with indicator dials the movement of the tuner is noted in any room equipped with a master box.

Some rooms are equipped with miniature boxes which do not include the station indicator or manual tuning keys.

The cables which go from the control boxes are no thicker than a lead pencil and all are run through galvanized iron pipes to distribution points.

The master of the house may always be assured of non-interference because of his favorite room being equipped with a lock-out switch. This permits others elsewhere in the house to listen, but only he may tune or operate the outfit.

The automatic record changer is a standard instrument equipped with a specially-designed 200-ohm pickup and a matching T-pad volume control. This mechanism is mounted in an almost sound-proof room.

A "NOISELESS" INSTALLATION

A "standard" installation of the equipment resulted in annoying sounds as the records changed, even though the doors to the cabinet were closed. In order to overcome this disturbance, it was necessary to line the cabinet completely with celotex and felt, and mount the turntable and motor on a felt-insulated board resting on sponge rubber. Upon closing the doors when this was done not a sound could be heard.

A hum frequency from the reproducers was another difficult problem, for, whereas a very slight hum cannot be heard in an (Continued on page 494)

Fig. 1, right. Block drawing of the A.F. output system showing how the many speakers are all connected to the audio rack.

Fig. 2, left. Details of the patented push-pull detector circuit used in this outstanding installation.

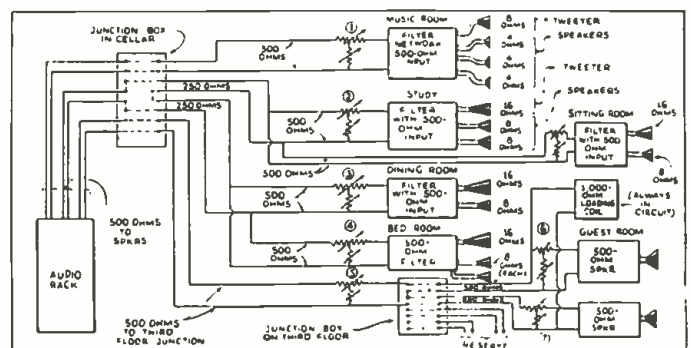

C. A. MORRISON

THE LISTENING POST FOR ALL-WAVE DX-ERS



A well-known short-wave DX-er—Mr. Irving Goodeve of Kalamazoo, Mich.



The Monte Ceneri 15 kw. broadcaster located in a remote part of the Swiss Alps.

IT IS the "unexpected" element in DX reception that makes it interesting. Radio will some day be a Science; at present, however, much about it is unknown. It is these mysterious elements, these unknown equations that fascinate DX-ers. There are many factors about DX reception that are inconsistent. Often the slightest change in weather, location, or aerial will bring amazing changes in our DX reception possibilities. Strangely enough some of our best DX-ers are located in busy city districts, surrounded by all kinds of interference.

My own reception location is far from ideal, as I am located on the corner of two busy streets with plenty of automobile traffic, and other sources of static to contend with, and yet by patient effort, I have managed to capture quite a number of elusive DX goals on the short waves. On the other hand I seem to be in a dead spot as far as broadcast band foreign DX reception is concerned.

During the season of 1931-1932 I lived on the same street, but two blocks distant, and yet my carefully-kept log shows I received as high as 18 or 20 trans-Pacific broadcast stations on some nights at that location. Since moving to my present location, despite improved aerials, more powerful transmitting stations, and more sensitive receivers I just can't seem to tune them in here!

EFFECT OF LOCATION ON DX RECEPTION

A slight difference in geographical location often makes a great difference in short-wave reception also. Recently I had the thrill of picking up TFJ, Reykjavik, Iceland (12.23mc.) direct, on the occasion of their broadcasting a program for North America. They were heard quite plainly, and with a good signal. A friend of mine with similar equipment, and in a much less noisy location at the edge of town was unable to even pick up the carrier wave of TFJ on this broadcast, although I let him listen to them over the phone from my own receiver! On the other hand this same DX-er tunes in the Japanese, Japanese, and Philippine phone circuits every night with good intelligibility while it is only rarely I am able to receive them here.

An even stranger experience occurred one night last winter when we were tuning-in the 7 mc. amateur channels for a certain Buenos Aires amateur. Two identical receivers had been set up in the same room in order that both ends of the conversation might be heard. On one receiver the Spanish ham was received with a good R8 signal, while on the other receiver the station could not be found at all, even after repeated attempts!

IMPORTANCE OF THE ANTENNA

There is little doubt that aerials play a very important role in DX-ing, especially in short-wave DX-ing. Give

me a fair receiver with a good aerial array, rather than an extra good receiver, and a poor aerial layout. The great importance of aerials is clearly demonstrated in the remarkably fine standard of program perfection that is attained in our network relays from foreign countries, which are picked up at Riverhead, Long Island or some other commercial receiving station preparatory to being fed to the chains. Often when we are barely able to hear the station which they are picking up, the same program on the broadcast-band relay is very excellent. The answer to this is, highly efficient directional receiving antennas plus battery receivers, and a quiet location. The tiny 8-W. transmitter of the Army Air Corps stratosphere balloon, W10XFH, which tested daily on 13.05mc., came in very well here—but only on one antenna. W10XFH could not even be heard on any of the other aerials! In this case the successful antenna was an *underground* one!

LSN3, Buenos Aires was heard here on their inaugural broadcast with very good signal strength, and audibility, with a 2-hour program, in which frequent announcements were made in English. I naturally thought every one DX-ing that evening would run across this station, and yet after 2 weeks not a single DX-er had reported reception of this broadcast. Can you account for this?

One morning nearly 3 years ago RNE, Moscow, was heard the first time and with a tremendous loudspeaker signal. Never since that time has RNE ever been heard with anything like this record volume. Apparently every condition for perfect transmission was present at that time.

NIPPONESE BROADCASTERS

Although up to this date foreign broadcast-band reception might be termed a wash-out this season, the Japanese broadcasting stations continue to roll in, for those DX-ers located in the western states. At this time of the year chances are best for receiving (Continued on page 496)

Broadcast stations have recently been erected in both Iceland and Greenland for supplying the natives with programs of their own music. The picture to the right shows a group of Greenland folks broadcasting native songs over the stations of the Danish Broadcasting Co.





The author examining the output of a receiver with the aid of the oscilloscope he won in Radio-Craft's recent contest! An oscillator and frequency modulator are essential. Fig. 1, below, Simplified block diagram of the units in the set-up.

OSCILLOSCOPE SERVICING OF ALL-WAVE SETS

The 1st-prize (oscilloscope) winner in Radio-Craft's recent service contest tells interesting facts about oscilloscope servicing.

E. E. SAYRE

ALIGNMENT of all-wave receivers by the cathode-ray oscilloscope method brings to light some interesting facts that are not usually noticeable in ordinary broadcast receivers.

One of the most interesting observations that can be made with the oscilloscope is in seeing the changes in the shape of the sensitivity curve of a receiver that take place as the set heats up after it is turned on.

To observe this phenomenon it is only necessary to connect the oscilloscope and its associated equipment to the receiver under observation as shown in Fig. 1, remembering of course that in making an experiment of this kind it is necessary to use a service oscillator and frequency modulator of known stability.

SET MUST REACH "OPERATING HEAT"

The receiver first should be allowed to run for a half-hour or so until it has been thoroughly heated, just as it would if it were in actual service, before beginning the alignment procedure.

Carefully align the receiver so (Continued on page 497)

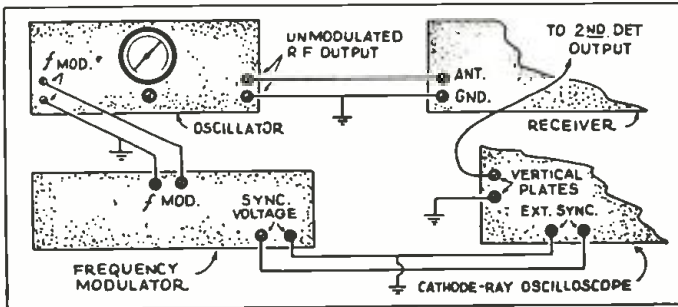

NEW METAL-TUBE CHASSIS SIMPLIFIES "MODERNIZING" OLD SETS

A metal-tube modernization chassis permits owner to retain an old, expensive radio cabinet—and speaker set-up.

TOBE DEUTSCHMANN

STATISTICS show that one out of every 3 receivers sold during the last half-decade has gone to replace an antiquated receiver rather than equip a new radio home. However, it is estimated that there still are close to 8,000,000 out-dated receivers in operation. The reason for this is the fact that most of these receivers were purchased during a period when the average price of a radio receiver was about

\$170.00, and the owners naturally are loath to junk what represents an investment of this nature. Also, many of these receivers are housed in expensive cabinets which have been especially selected to harmonize with some particular scheme of decoration.

However, the advantages of modern radio reception may be had by complete modernization of the old receiver; and it is possible to accomplish this at a cost considerably under that of a new receiver giving comparable results. In this system (to be described) the cabinet and often much of the old receiver are retained, thus safe-guarding the original investment.

THE MECHANICS OF MODERNIZATION

There is no place in this article for detailed concern with the technical considerations associated with modernization. It is assumed that the Service Man is an ex- (Continued on page 509)

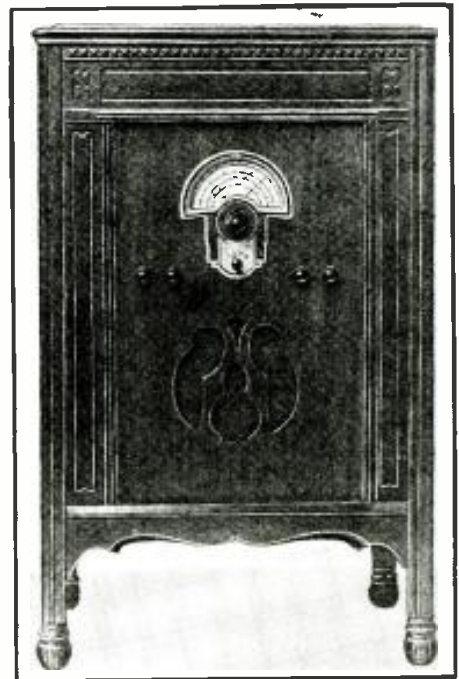

Above, Fig. A, a rebuilt set housed in an owner's original R.C.A., RE17, cabinet. A new panel has been made. Below, Fig. B, a comparison of the old and new panels.

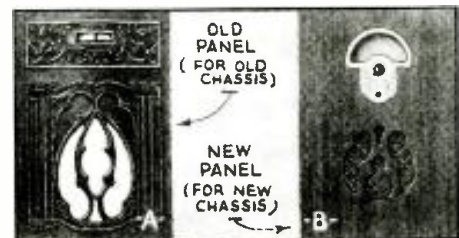
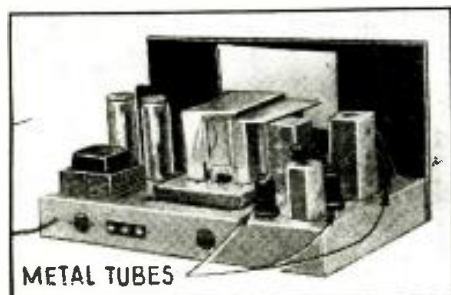

SERVICING THEATRE SOUND SYSTEMS

In this (concluding) part, high-fidelity, speaker installation and placement, and screens are discussed.

A. V. DITTY

DYNAMIC SPEAKER field supplies for A.C. use a transformer and either an 80-type tube with condenser filter or a dry-disc rectifier with condenser filter for the D.C. voltage. Units used with air-column horns have a field supply of the latter type. The chief source of trouble is in the rectifier, causing hum and low voltage to the field and consequently low volume from the inefficiency of the field. Leaking or open-circuited condensers will cause considerable hum in the speaker unit.

CORRECTING FAULTY REPRODUCERS

Rattling or rasping sound from the speaker units might be caused by metal filings or other foreign particles between the voice coil and the field core or housing. Loose or torn diaphragms or cones, warped voice-coil cores rubbing against the field core, or loose voice-coil windings will also cause fuzziness. Use either thin shellac or flexible collodion for repairing the cones or voice coils. A magnetized needle or other small-pointed object and a pipe cleaner will usually get the filings out. After cones or diaphragms get old or warped they may have a resonant point other than their natural resonating point, at which a "tinny" or "rattling" sound will be heard. The best thing to do in this event is to replace the cone and diaphragm. Voice coils may be centered by cutting an ordinary calling card into strips about a quarter-inch wide and inserting them, properly spaced, between the voice coil and the field core. Remove strips after tightening the centering lock screws. Use the above procedure for servicing both types of units. Sometimes grounding

the speaker unit and field-supply case will help to lower the A.C. hum level.

The number of reproducers required and the proper placement of them will be controlled by the size and shape of the auditorium, and limited by the power output of the amplifier. An item of much importance in speaker installations is the *speaker efficiency*, that is, the ratio of the amount of electrical output of the amplifier to the amount of acoustical power delivered by the reproducer (or, the amount of electrical energy of the amplifier transferred to acoustical energy by the speaker or reproducer).

Contents Cubic Feet	No. of Seats	Undistorted Power Output
75,000	500	5 Watts
200,000	1400	10 Watts
600,000	2500	20 Watts
1,100,000	4000	40 Watts

DETERMINING REQUISITE REPRODUCERS

With the cone-type dynamic units, the efficiency ranges from 3 to 10 per cent with the later reproducers, while the air-column horns or exponential horns are rated at 40 to 50 per cent efficient. The latter are favored in long and comparatively narrow houses, while the former are used with flat baffles or directional horns to suit the wider houses or for special placement. In the very wide houses and houses with balconies, banks and rows of speakers on flat, adjustable baffles or in adjustable, directional horns, provide for proper sound distribution.

The purpose of the exponential horn (or air-column horn) is to isolate a column of air and to set up sound vi-

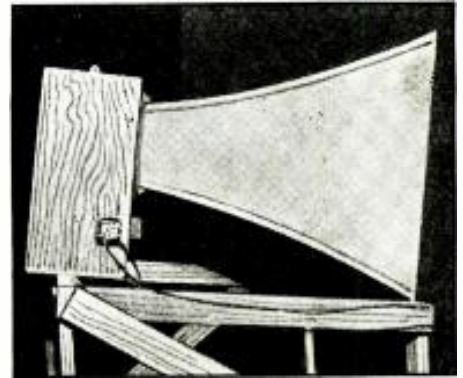

Fig. E. An exponential horn with a cone-type dynamic unit. Note the angle for proper sound distribution.

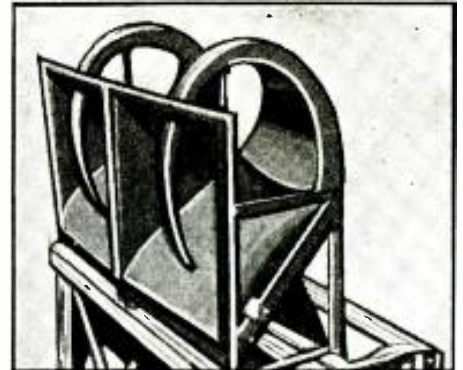

Fig. F. Twin exponential horns mounted on a movable tower for correcting defective distribution.

brations therein. The exponential horn itself is not an amplifier of sound waves as is commonly supposed, but is a device to match the high impedance of the speaker unit to the low impedance of the isolated column of air. The horns should be placed nearest the center of picture voice action, that is, about two-thirds of the way up and in back of the screen. Speakers should be mounted with the imaginary sound beam center lines directed as in Fig. 9A to F. All drawings are self explanatory.

SOMETHING ABOUT Baffles

Baffles for cone-type dynamic reproducers should not be less than 4 ft. square, with a maximum of 10 ft. square. The baffle board should be of some soft, non-resonating material such as 1/2-in. celotex or masonite and should be placed 2 or 3 ins. from the back of the screen. Baffles should be painted a dull black so as to not reflect any light from the picture source. (Using wood for baffles defeats the purpose of a baffle by making a sounding board out of it and giving increased amplitude to the particular frequencies at which the wood will resonate. This will give peaks on the sound curve, while the object is to keep the curve as nearly flat as possible.) If the theatre is too reverberant, use a small baffle, as this is intended to slightly attenuate the lows, thus minimizing any boominess in the sound without any appreciable loss in quality.

When the speaker cone moves in and out to make the sound vibrations it causes a slight vacuum behind the speaker diaphragm. Without a baffle board the air from the front goes

(Continued on page 495)

Fig. 9. Details of speaker placement and elevation, for correcting sound distribution.

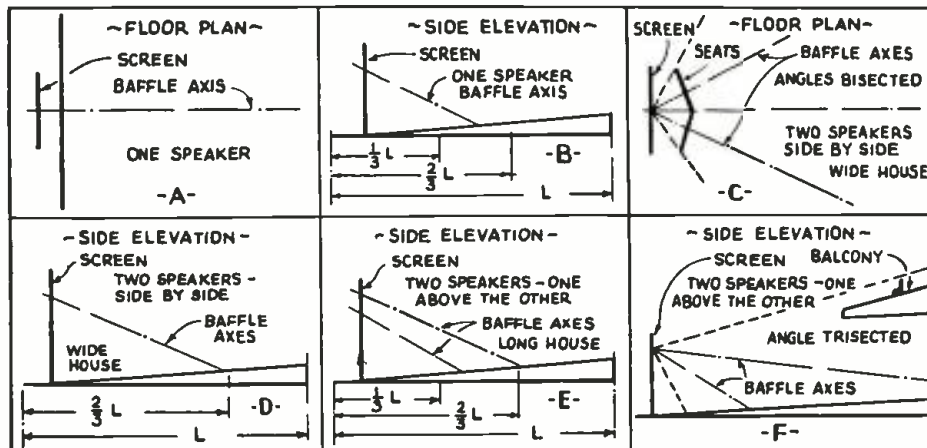

SHORT-CUTS IN RADIO

FIRST PRIZE \$10.00
 SECOND PRIZE 5.00
 THIRD PRIZE 5.00
 Honorable Mention

EXPERIMENTERS: Three cash prizes will be awarded for time- and money-saving ideas. Honorable mention will be given for all other published items. Send in your best "kinks"!

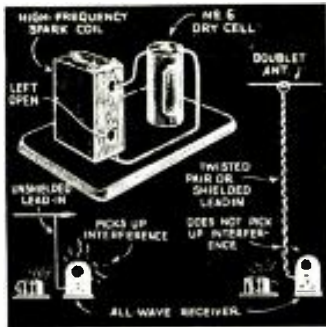

Fig. 1. Antenna tester.

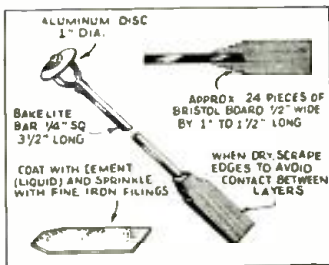

Fig. 2. Home-made tuning wand.

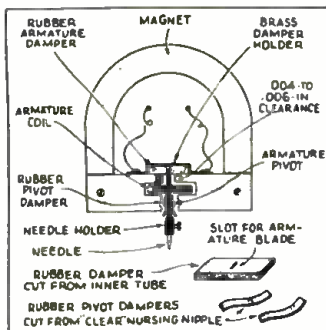

Fig. 3. Repairing a defective pickup.

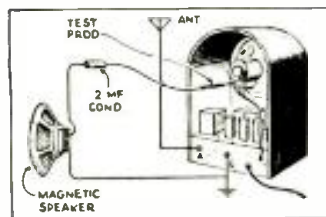

Fig. 4, above. Quick speaker test.

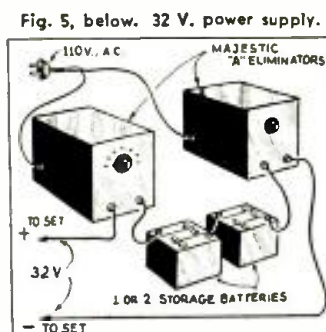

Fig. 5, below. 32 V. power supply.

FIRST PRIZE—\$10.00

ANTENNA TESTER. After installing an all-wave antenna the Service Man is never sure that it is a perfect job. The device shown enables a test to be made immediately!

It consists of a model T Ford spark coil and a single dry cell. These may be mounted compactly (see Fig. 1), so that they can be put in the tool kit. The apparatus is simply placed near the receiver or lead-in and turned on. Disconnect one lead of a transposed feeder system, use the other as the antenna, and the noise will come in strong, but, if a good job has been done on the antenna, the regular doublet connection will give a minimum of noise.

A. WARD HOWE

SECOND PRIZE—\$5.00

TUNING WAND. This handy piece of equipment may be made by reference to Fig. 2. An aluminum disc 1 in. in dia. is fastened at one end of a bakelite rod. At the other end is a core made of iron filings glued to cardboard strips. The edges of the completed core must be scraped to insure that there will be no contact between adjacent layers of iron filings.

C. P. WILLOUGHBY

THIRD PRIZE—\$5.00

PICKUP REPAIR. Other than actual burn-out, trouble in pickups is usually caused by drying up of the rubber armature dampers. Repairs can easily be made with rubber from an inner tube which still has good resiliency, and bits from a (transparent) rubber nursing nipple. Use care, when taking the assembly apart as the fine wires from the coil break off with the slightest pull.

RALPH BILLS

HONORABLE MENTION

SPEAKER TESTER. Many midset S sets which can barely be heard with the volume full-on, will be found to have a faulty reproducer. A rapid test for this condition is shown in Fig. 4. It merely consists of a 2 mf. paper condenser in series with a small magnetic speaker and a set of test prods. With the set turned on and tuned to a local station, touch all the terminals on the speaker with one of the prods, the other being grounded. If the set is in good condition otherwise, a signal will be heard in the magnetic speaker.

HARRY E. WESSEL

Fig. 6. Soldering-iron kink.

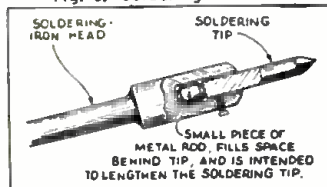

HONORABLE MENTION

32 V. POWER SUPPLY. Many Service Men are at a loss when called upon to test, or do work in their shops on, 32 V. radio sets. Ample power for the purpose may be secured from the arrangement shown in Fig. 5. The old Majestic "A" eliminators deliver between 12 and 15 V. when the chokes are removed. Hooked in series with one or two 6 V. storage batteries, a handy 32 V. power supply is available.

HERBERT MALVIN

HONORABLE MENTION

SOLDERING IRON HINT. A small length of copper rod the same diameter as the tip is inserted in the space behind the tip. This insures that the tip will remain tight in the seat. Simple as this idea may seem, it is very effective. See Fig. 6.

EUGENE KONGREY

HONORABLE MENTION

SCRATCH REMOVER. This idea, S shown in Fig. 7, is a remover that will eradicate the worst scratch, yet costs only a few cents to make. Grind up about a dozen pecan kernels, taken fresh from the shells and rub them into a piece of cheese cloth. You now have one of the finest scratch removers it is possible to make. The cloth will last for a year or more before needing renewal of the pecan oil. Simply rub the cloth over the scratch, let the oil dry a few moments, and polish with a clean, dry cloth.

MORRIS DORSEY

HONORABLE MENTION

FILAMENT RESISTOR. The filament resistor shown in Fig. 8 can be made very cheaply and will not burn out or cause other trouble. In addition it is very handy, since it is adjustable. The insulator which is used as the base can be obtained in several lengths, thus several different ranges of resistance can be made. No wire smaller than No. 14 should be used.

The wire is wound on the form first, and then the enamel is scratched off along a narrow line to allow contact with the slider.

L. H. GEORGER

(Continued on page 497)

Fig. 7. Scratch remover.

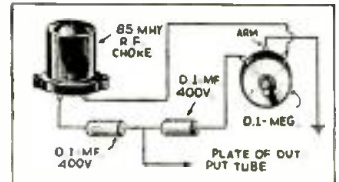
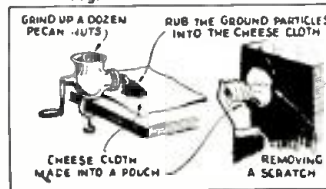

Fig. 13. Novel tone control.

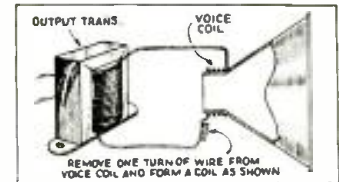

Fig. 12. Dynamic speaker repair.

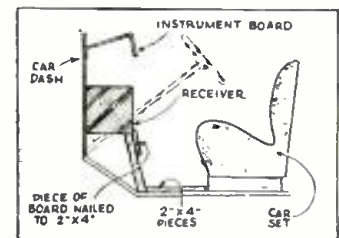

Fig. 11. Installation help.

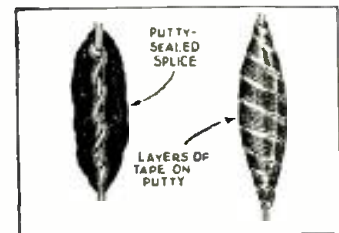

Fig. 10. A weather-tight joint.

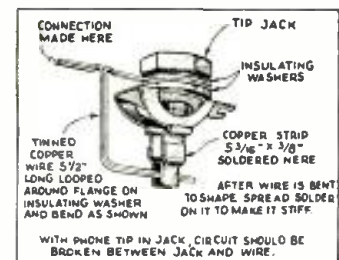
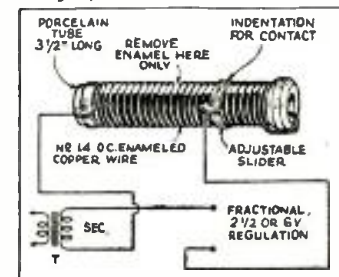
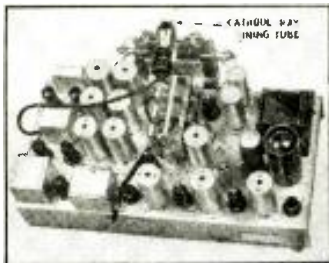

Fig. 9, above. Re-making a tip jack.

Fig. 8, below. Filament resistor.



THE LATEST RADIO EQUIPMENT



Latest metal-tube set. (895)

NEW ALL-WAVE RECEIVER (895)

(RCA Manufacturing Co., Inc.)

THE MAGIC EYE tuning tube is used in this new chassis which incorporates 15 tubes. Five bands are used covering a tuning range of 140 to 60,000 kc. The undistorted output is 10 W., and the set draws 145 W. from the power line. Provision is made for the use of a phono. pickup and a switch changes the set from phono. to radio. All the tubes are of the new metal type, except the rectifier and the cathode-ray tuning tube.



Wind-driven battery charger. (896)

WIND CHARGER (896)

A 6-VOLT charger is illustrated which is designed for use in localities where there is no available line power for battery charging. The storage battery is kept charged automatically, and the apparatus shuts down when charging is complete. The generator and propeller tilt automatically to keep the charging rate constant regardless of wind speed. A meter indicates current output.

CATHODE-RAY-INDICATOR ADAPTER (897)

OWNERS of any radio set that has A.V.C. may now equip their set with the latest development—the cathode-ray indicator—through the use of this adapter.

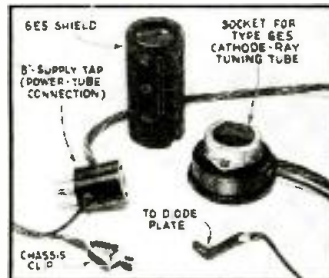

Adapter for 6E5 tuning tube. (897)

PRECISION TUBE TESTER (898)

(Precision Apparatus Co.)

OVER 300 tube types are fully tested by this instrument; all dual-type tubes are given individual section tests. All tubes are tested under rated load. Has neon condenser leakage test; and hot-cathode leakage and inter-element short tests between any elements. Line voltage checks on main meter. Available in portable, panel and counter types.



Above, new tube tester. (898)

UNI-DIRECTIONAL MICROPHONE (899)

(Brush Development Co.)

UNI-DIRECTIONAL microphones are of special value to the P.A. technician who is troubled with



Below, crystal microphone. (899)

All-wave oscillator. (900)



New style A.C.-D.C. set. (901)

acoustic feedback. The crystal microphone illustrated is "dead" at the back; at front, field extends over 180 degrees. By a switching system in the preamplifier, this instrument can be changed instantly to a completely non-directional unit!

ALL-WAVE OSCILLATOR (900)

A FREQUENCY range of 90 kc. to 60 mc. is covered by this instrument. A direct full-vision dial is used with a transparent pointer to eliminate parallax. A modulator tube provides about 35 per cent modulation. Incorporates batteries. Case is of steel, deeply etched and copper plated brass panel. The oscillator is calibrated at the factory from crystal standards over all bands.

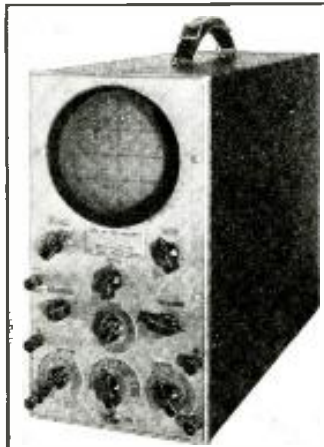

Laboratory-type oscilloscope. (902)

NEW COMPACT RECEIVER (901)

SIX TUBES are used in this new set. It is of the superhet. type and has 2 bands, 550 to 1,600 kc. and 70 to 185 meters. A full-vision dial is used, the dual pointers being illuminated. The power cord runs cool since the resistor is in the form of a tube. A dynamic speaker is used. The cabinet measures 13 3/4 x 9 x 6 ins. deep and the set weighs 8 lbs.

OSCILLOSCOPE (902)

MANY NEW and exclusive features are claimed for this instrument. Either the 3 or 5 in. tube may be employed. A new sweep circuit is used as well as a new coupling circuit for the input. Two amplifiers are provided, which may be used separately or in cascade. The 5 in. tube is supplied with a calibrated scale. A 6-position gang switch shifts the input so that different connections are secured.

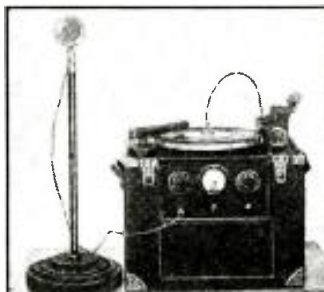

Recording machine. (903)

PORTABLE SOUND RECORDER (903)

(Sound Apparatus Co.)

THIS MACHINE can be operated by the most inexperienced person. for recording and reproducing voice or other sounds. Furnished with crystal microphone, crystal pickup, (Continued on page 499)

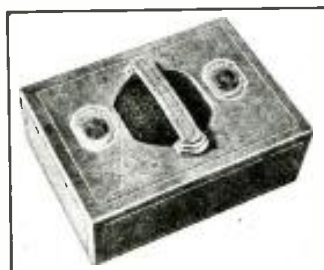

Above, portable superhet. (904)

Below, A.F. amplifier. (905)

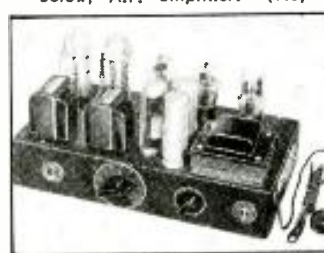

Counter-type tube tester. (906)



Name and address of any manufacturer will be sent on receipt of a self-addressed, stamped envelope. Kindly give (number) in above description of device.

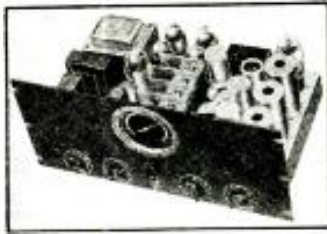

Entertainment system. (913)

ENTERTAINMENT SYSTEM (913)

(Wholesale Radio Service Co.)

SERVICE MEN will find that there is a large field installing entertainment outfits, such as that illustrated above. Many prospective customers refuse to install an amplifier a receiver, or a phono outfit, because they are not complete. This new unit contains all these in a handsome cabinet, and the 20 W., high-fidelity output is sufficient for most requirements.

Radio tuner and amplifier each have their own chassis, the amplifier chassis power supply being used to supply the receiver as well.

The T.R.F. radio tuner has a pre-selector providing the necessary selectivity to completely cut out strong local stations. The detector is of the diode type and its output is fed into the audio system through a volume control.

The audio system utilizes resistance coupling throughout, except, of course in the final stage where transformers are required. Various leads or taps are provided on the output transformers to enable connection to any line or speaker. The input of the amplifier is arranged to use 2 microphones or other sources, such as phono pickups. A separate volume control is provided for each input channel as well as for the radio input.

Specifications are: peak output, 35 W.; gain, 108 db.; hum level, -50 db.; power consumption from

(Continued on page 500)

FARM RECEIVER (914)

(Allied Radio Corp.)

ALTHOUGH this set is called a "Farm Set," it is designed for use wherever power lines are not available.

The receiver is a 6-tube superheterodyne built to have the lowest possible current drain consistent with practical standards of operation. As a result it draws a total of only 1.25 A. from a 6 V. battery. No other batteries are needed. All the latest features, such as A.V.C., all-wave operation (17 to 565 meters), airplane dial and rubber-mounted tuning condenser are included. Tubes required are: 1-1C6, 1-34, 1-33, 1-32, 2-30s. The high volt-

Low drain superhet. (914)

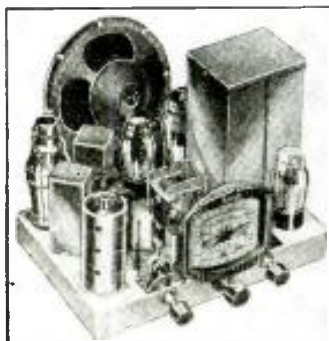

Wind battery charger. (914)

age power supply is of the self-rectifying, full-wave type, mounted on the set chassis. Either a console or table model may be had.

The recommended method of charging the battery in outlying districts is by means of the wind-charger pictured above. This unit has an automatic governing mechanism, which functions to keep the charging rate at a substantially constant value, regardless of the wind velocity. Thus the battery will not be harmed if the wind reaches a speed of 65 m.p.h. or more. The speed is kept constant by a mechanism which tilts the propeller and generator as the wind increases. This action does not start until the wind velocity reaches 20 m.p.h. The

(Continued on page 500)

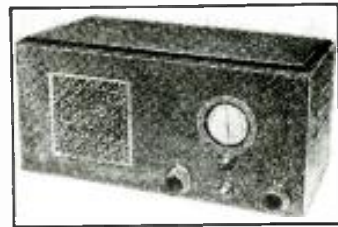

Self-contained set. (915)

BANDSPREAD RECEIVER KIT (915)

(Eilen Radio Labs.)

MANY features are included in this kit, which enable the builder to construct a fine all-wave receiver. It is intended for all types of usage, such as amateur, S-W. broadcast and all other types of reception.

There are 5 tubes used, and either metal or the newer glass tubes may be employed. The tubes are used as tuned R.F., regenerative detector, 2-stage A.F. amplifier, and rectifier. The set is completely self-contained, the power supply and speaker are mounted in the same case as the receiver proper. The old reliable and highly efficient plug-in coils are used. The case is of heavy steel, finished in black crackle lacquer.

The dial is of the dual pointer variety, and is illuminated. There are two speeds for tuning, the slow speed being used for bandspread. By the use of this system the S-W.

(Continued on page 500)

Circuit of the short-wave 5-tube set using tuned R.F. (915)

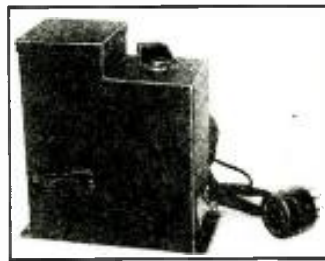
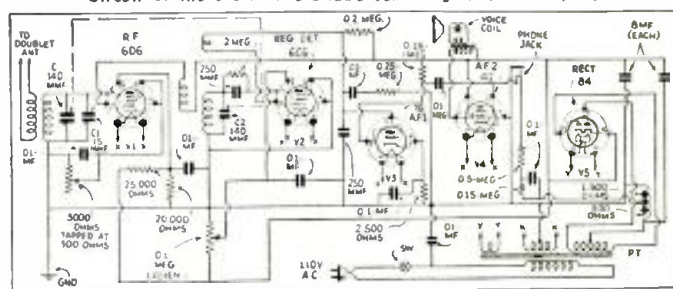

Beat oscillator. (916)

MULTI-PURPOSE OSCILLATOR (916)

AVARIETY of uses are served by this compact unit. Some of the uses for which it has already been employed are:

A beat-note oscillator to read code C.W. signals on a receiver which is not equipped with such an oscillator. It will make virtually any superhet. receiver capable of bringing in unmodulated S-W. signals.

As a beat oscillator for locating weak carriers when hunting for DX. This is accomplished by the so-called "whistle method." As an oscillator to broadcast phonograph music or voice to your radio receiver. By this same means you can use any ordinary broadcast set as a P.A. system, with a coverage only limited by the capabilities of the A.F. system of the receiver. This type of P.A. system is very versatile since the receiver does not need to be tampered with in any way and the entire amplification is used. By providing a modulated signal to the input terminals of the beat oscillator, the intermediate frequency stages of the superheterodyne may be lined up to peak efficiency.

Many other uses will probably be found, but these are the outstanding ones conceived, in most cases, by the originator of this particular unit.

Most present-day superhets. use an intermediate frequency of between 430 and 500 kc. When the beat oscillator is once adjusted to the intermediate frequency of your particular set, it will not have to be touched again, unless of course the intermediate amplifier is re-aligned. The only operation needed is that of turning the oscillator switch on or off, as needed.

To tune the unit to your particular receiver it is only necessary to tune in a weak signal on the set, then turn on the oscillator and turn the tuning control until a whistle is heard in the speaker. This whistle will then appear at every station tuned in, as long as the beat oscillator is on. It will be noticed that each station produces two distinct whistles, very close together, with a quiet point between the two which is called the zero-beat point. It is to this zero beat that the station is tuned, when the oscillator is used as a station finder. When the center of the two whistles is found the oscillator is turned off and the station will be found to be tuned in exactly right.

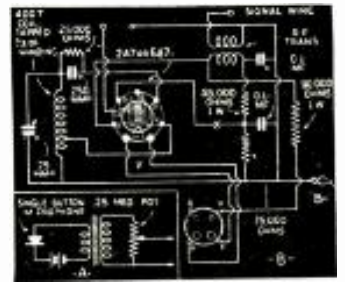

Beat-oscillator circuit. (916)

For use with a microphone a mike transformer and battery are needed, and a potentiometer to regulate the volume is helpful, although not absolutely necessary. When a phono pickup is used, the output may be connected directly to the input terminals, providing the ordinary high-impedance type of pickup is employed.

Only one tube is used with this unit, the power being supplied from the set it is used with, by means of an adapter which is placed in the socket of the power tube. The tube is a pentagrid converter (6A7 or 2A7) which is used both as modulator and oscillator. The so-called anode grid is not used in this circuit as it was found that its omission enabled a higher percentage of modulation to be obtained. Besides the power tube adapter, two other connections are made to the set—the clip which goes to the chassis, and the other lead (signal wire) which is wrapped on the I.F. amplifier control-grid lead.

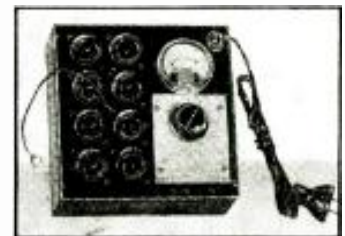

Compact tube tester. (917)

SELECTIVE ANALYZER AND TUBE TESTER (917)

(Tefft Radio Co.)

TWO very useful servicing units, companions to each other, have just been announced.

The Tube Tester

Illustrated above is this new unit, which is very simple in construction and in operation, yet it will test over 150 tubes including the complete new metal line. There is only one adjustment to make before testing any tube, this being the setting of the filament voltage switch.

The meter is of the zero adjustment type and is protected from accidental overload by a fuse which may be readily replaced without tools.

(Continued on page 500)

A convenient set analyzer. (917)

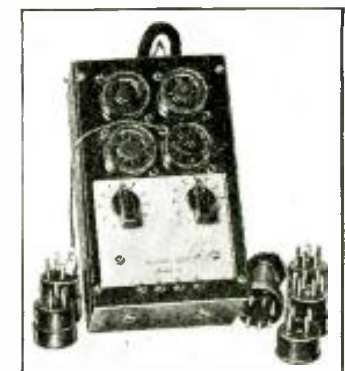



IN RE "THE TRAVELING SERVICE MAN"

RADIO-CRAFT, ORSMA Department:

As a regular reader of *Radio-Craft* we have noticed from time to time, descriptions and pictures of P.A. equipment, which you have printed.

We submit a picture of our truck, with the equipment that is carried. We have been in P.A. work for some time and find it a great financial help in conjunction with radio repairs. We will not take any of your valuable space to describe our apparatus, as it is mostly standard.

We employ a W.E. microphone in the truck with a simple device for changing from records to speech equipment (designed by the writer). Ordinarily a switch is used for this purpose. In our case a 5-wire microphone cable is used in place of the 3-wire cable generally used. On the base of the microphone is a push-button which is connected to a relay. This arrangement is very convenient because the announcer can pick up the microphone at any time and with the button, control both microphone and speech. A few difficulties were encountered, such as the loud click which would occur when the relay changed from one position to the other, with the mike current on. All problems finally were solved and the system works perfectly, now.

(If anyone interested in this control system will write us, we will be glad to give them all the "dope.")

NILS E. SEGERDAHL,
East Northport, L.I.

Our July 1935 *Radio-Craft* theoretical cover subject, "The Traveling Service Man," comes to life in this profitable sound and service truck of Mr. Segerdahl!

ANY SUGGESTIONS?

RADIO-CRAFT, ORSMA Department:

For the first time, since I've become a member of the ORSMA, I feel I need some helpful suggestions.

My job was to eliminate noise in a Philco Transitone installed in a 1934 Ford sedan. The set worked fine when the car was standing still, whether the motor was running or not (over-looking some noise from the "B" motor-generator).



Starting to drive: everything was OK until the clutch started to grip, the noise stopping when the clutch was engaged. (At this time I thought it might be static electricity generated by the friction of the clutch.) Driving on, the noise was not noticed when slipping the clutch in shifting to second and third. Some rough roads were tried, but caused little, if any noise.

When the brake was applied the noise was there again. I found that the clutch pedal rubbed against the ungrounded metal floor piece; grounding this however made no difference.

With the motor off, I had someone push the car and almost every time I pushed the brake pedal the noise was there again!

The owner also claimed that noise was noticeable when he accelerated, especially when he was going up hills, but it wouldn't work that way for me.

I grounded the brake rods, dash control rods, pedals, etc., but to no avail.

(Note: I did not install the set, but it was equipped with plug suppressors, generator condenser, and roof antenna, but no distributor suppressor.)

(I have just learned that the noise has been evident only since the V8 motor was changed.)

Would greatly appreciate any suggestions.

WM. MESSERSCHMIDT,
Rutledge, Penna.

Mr. Messerschmidt, an experienced radio man, has encountered a tough one. If grounding car motor to car frame does not do the trick, refer to "Obscure Sources of Car-Radio Noise," June, 1935 issue, page 729, etc.; also, "Front-wheel Static," page 738; and, "Short-Cuts in Car-Radio Service Work," page 742.

AN ORSMA BOOST

RADIO-CRAFT, ORSMA Department:

As a member of the ORSMA, I wish to express my appreciation concerning your interest in this organization and I am very glad to see *Radio-Craft* has devoted space in its pages for the development of it.

I have received my first issue of *Radio-Craft* and as soon as my subscription expires (to the ORSMA Bulletin) I assure you I will become a regular subscriber to *Radio-Craft*.

ROBERT L. CASPER,
Box 36,
Lloyd, New York.

CONTINUING—"DEFECTIVE VIBRATORS"

RADIO-CRAFT, ORSMA Dept.:

Referring to Mr. Jesse Smith's letter in the Member's Forum of the January 1935 issue of *Radio-Craft*, regarding the defects in various makes of vibrators for (Continued on page 501)

A SCHOOL-TYPE BROADCAST STUDIO

Here prospective artists and technicians are trained completely in the technique of radio program broadcasting.

THE PRESENT high standard of modern broadcasting technique makes it imperative for the owners of broadcast stations to employ monitoring men, operators, and varied other station technicians who are thoroughly experienced in the operation and maintenance of the equipment used for this purpose.

Conditions being such, it is obvious that if a radio student intends ultimately to attain a position as a technician in a broadcast station, he must in some manner receive his preliminary training and experience on the same type of equipment as used for broadcasting and to have the opportunity to work under the same conditions and environment as found in the better class of broadcast stations.

To make this possible, a West Coast school has developed a highly successful plan.

In addition to conducting a technical radio school they also operate in the same building a school of broadcasting,

the purpose of which is to train talented individuals in the arts of singing, dramatics, announcing, continuity writing, etc. The members of the faculty in this division of the school are all eminent radio stars of the Pacific Coast who have had years of experience before the microphone and are, therefore, capable of supplying students with a most valuable form of instruction.

An artist's cut-away section of the studios appears in Fig. B and it is here that the classes in broadcasting are conducted. These studios are of the most modern design from a technical standpoint, as well as being of architectural attractiveness and furnished according to professional practice.

While the students of the broadcast school use the studios to their particular advantage, yet this equipment is of mutual benefit to the radio students of the technical school who are privileged to act in the capacity of studio and station technicians, in addition to gaining the most valu-



Fig. A. Students operate entire station. Fig. B, below. Cutaway view of the diversified equipment available.

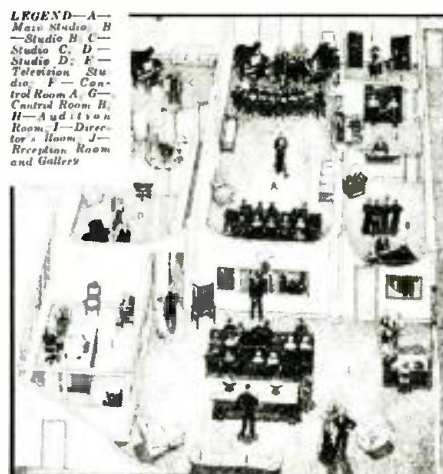

Above, the new amplifier in use as an amplifier for a guitar. A "crystal cell" is required for faithful rendition; it's easily attached to any instrument.

A BROADCAST P.A. UNIT FOR MUSICIANS

A new field has opened in the P.A. line—that of supplying musicians with sound-amplifying systems such as this one.

CHAS. R. SHAW AND M. RECHT

WITHIN THE last few years progress in A.F. amplification has gone forward with leaps and bounds. It is only within recent months, however, that the layman has had his interest awakened in this field. The popularity of sound systems has in-

creased to such an extent as to invade the portals of firms which have previously had no particular interest in anything electrical. Music concerns, interested only in manufacturing and selling musical instruments, have gone into the field of audio amplification to satisfy the demand for it created by orchestras and singers. Manufacturers of guitars and other string instruments have had amplifiers and microphonic devices built especially for these instruments so as to increase their tonal volume. People in all walks of life, as well as musicians, have found sound systems valuable adjuncts for their own personal use.

The result of this popularity has been to create new standards for sound systems. Permanent installations are not suitable for personal use. The outfits used by sound engineers are too complicated for the average layman and are too clumsy to carry about. Portable systems are often lacking in power and quality. Musicians, the most critical of any group of

Below, circuit of amplifier; only high fidelity will satisfy musicians' unions. Note use of 2 input channels.

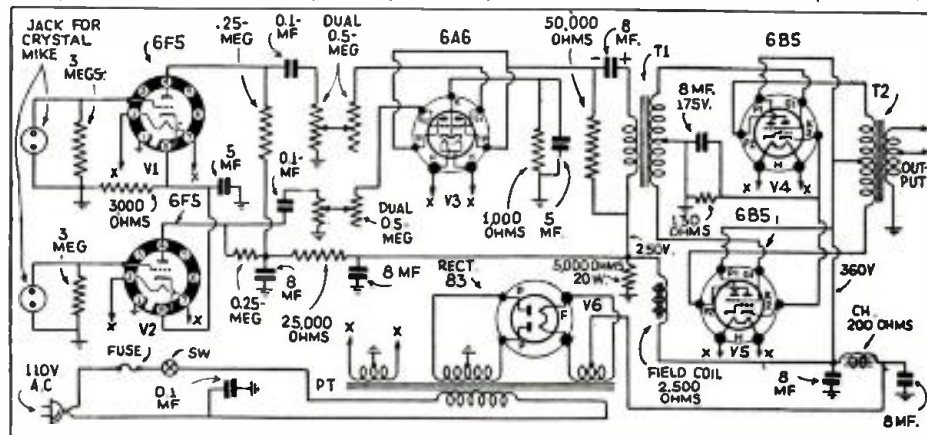

GENERAL ELECTRIC MODELS A82 AND A87, 8-METAL-TUBE ALL-WAVE A.C. SUPERHET.

(All metal tubes; extended long-wave band; dual-ratio tuning drive; 7 W. maximum output; 10 in. reproducer; sentry box; "permaliner" trimmers.)

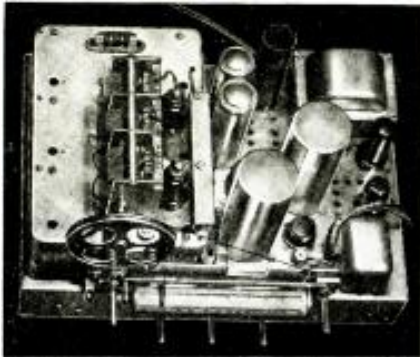

Above, the sentry box is on the left.

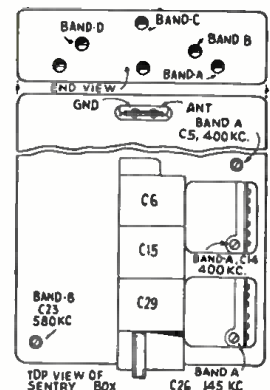
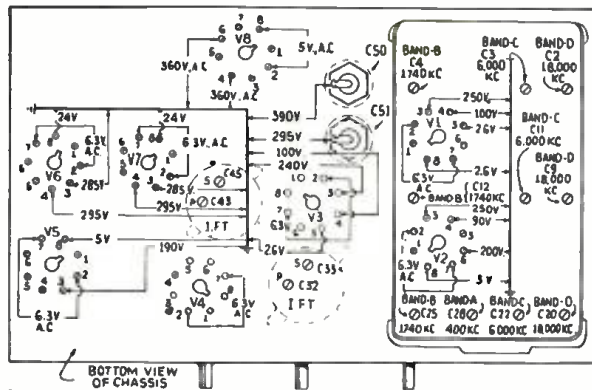

The "sentry box" is the outstanding feature of this set. It contains all coils, the band switch, the R.F. tube V1, the det. 1 and osc. tube V2, and all components of the circuit associated with these units.

Before starting any adjustments on the set, it is advisable to make certain that they are needed, and the use of a "service wand" is the quickest way to do this. Holes are provided in the coil shields to admit the wand without disturbing any parts of the set, so that the test is made under normal operating conditions. (The wand consists of a rod of non-magnetic material having a ring of non-magnetic metal attached to one end, and a small core of finely-divided iron at the other.) The following table shows what circuit adjustments are needed for various indications when using the wand.

End	Signal	Trimmer Adj.
Metal ring	Decrease	None
Iron filings	Decrease	None
Metal ring	Increase	Decrease Capacity
Iron filings	Decrease	Decrease Capacity
Metal ring	Decrease	Increase Capacity
Iron filings	Increase	Increase Capacity

Holes are provided in the coil shields for insertion of the wand in any Ant. or R.F. coil. No provision is made for its

use in any of the oscillator coils since these may be checked by noting the dial calibration.

On all the "permaliner" trimmers used in this set, clockwise rotation of the adjusting screw decreases capacity while counter-clockwise rotation increase it.

Note that the full available A.V.C. voltage is applied to the R.F. tube, while reduced voltage is used on the converter and the I.F. stage.

The volume control used in this set is of the dual type, but both sections are not used for actual control of volume, since R22 is used as a tone compensator by increasing the low-frequency response as the volume is reduced. The regular tone control, R23, may be used independently.

Alignment of the set is accomplished by the usual routine. An oscillator with frequencies of 140 kc., 410 kc. (Band A); 465 kc. (I.F.); 580 kc., 1,740 kc. (Band B); 6,000 kc. (Band C); and 18,000 kc. (Band D), is needed for proper alignment, and an output meter must be used for proper results.

The sentry box assembly may be dismantled as a complete unit by removing the side-fastening bolts, unscrewing the dial-mechanism fastening nut and unsoldering the leads to the chassis from the terminal strip.

In order to remove the coil shield cans it is necessary to remove the band-switch shaft. With the sentry box removed from the chassis the dial gears may be disengaged and the shaft removed merely by lifting the reduction drive and of the dial assembly, allowing the switch shaft gear to pass the dial scale cap shaft. With the sentry box mounted in place, removal of the switch shaft requires removing the dial scale gear and cap shaft.

Three transformers are available for use with different power supplies. Type A is for use on 105 to 130 V., 50-60 cycles, A.C. Type C is used on the same voltage but 26 to 60 cycles. Type V may be used on 105-250 V., and 40-60 cycles. The connections of the various types are shown on the circuit diagram. Types A and C are similar to the transformer connected in the circuit, while Type V is illustrated at the lower right.

Permaliner trimmers may be replaced by merely removing their particular shield can. It is an easy matter, however, to remove each complete bracket assembly by taking out the mounting bolts and unsoldering the braid connection to the tuning condenser. In the case of the oscillator and R.F. units it will also be necessary to remove the connections to the respective terminal boards of these units.

Circuit diagram. The dashed enclosure at left encompasses the circuits of the sentry box.

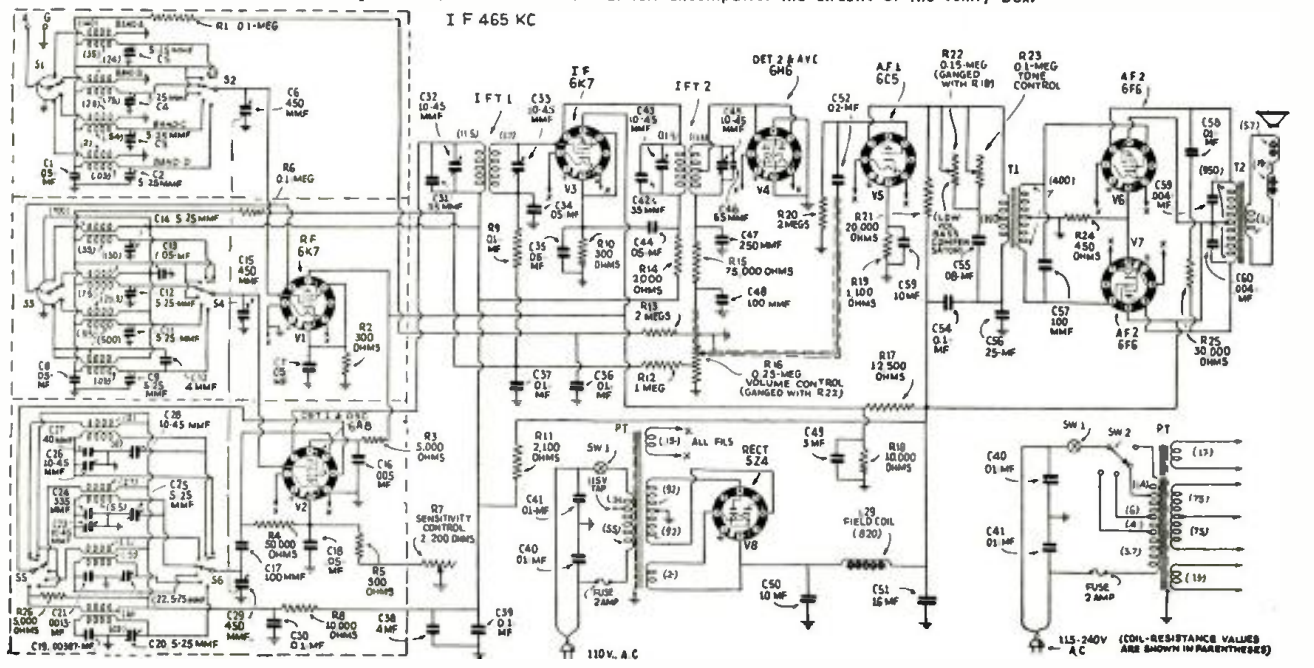



INSTRUMENTS COULD TALK...

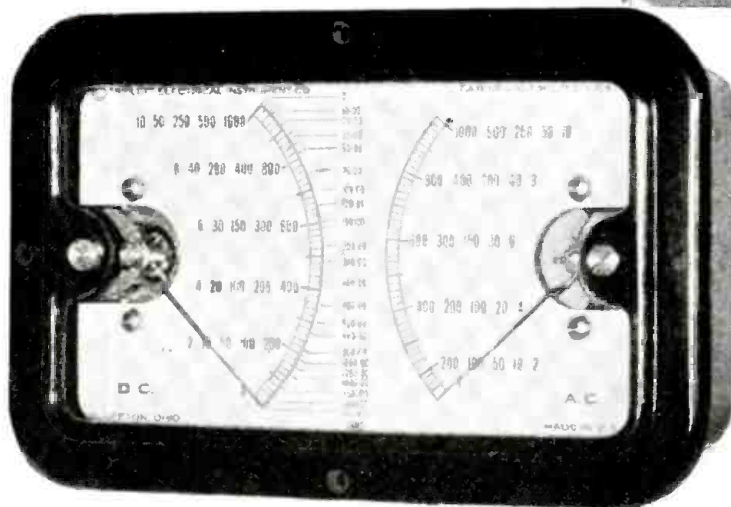

You could easily find out why each Triplett instrument is guaranteed to maintain accuracy within 2%. (Some are guaranteed to maintain accuracy within 1%). First the design—Tried and checked from every angle. Then the selection of material—The finest without reservation. The construction and assembly—Master craftsmen and factory workers with years of instrument manufacturing training. Final inspection—Checked by experts. Each step shouts Triplett Quality.

Precision Without Extravagance

TWIN Instrument

Standard Combination No. 120 (Same dial as used in Triplett Model 1200 Master Volt-Ohm-Milliammeter.)

TWIN Instrument

Dealer Net Price, \$10.33

The Twin is furnished in any combination of standard 3" A.C. or D.C. movements. Both are included in the special rectangular molded case that requires a minimum of space for special installation.

Simultaneous readings can be taken on both instruments when connected in same or separate circuits. Prices on special combinations given on request.

Model 321 O-I-D.C.

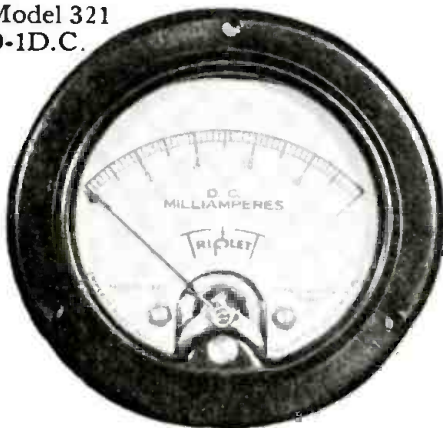

Model 521—Volt-Ohm-Milliammeter

Dealer Net Price, \$7.00

Beautiful in Appearance, yet Accurate to 1%. Body 4 3/8". Flange 3 1/4". Body depth, 1 1/2". scale length 3 1/2". Knife edge pointers, molded Bakelite Case. Flush Mounting.

An extra large Foundation Instrument. Has long visible scale. An instrument that stands out on your test panel. Can be used to handle practically any values by using proper shunts and multipliers. Available also in projection mounting.

Model 321—O-I-D. C.—Milliammeter

Dealer Net Price, \$4.67

3 1/2" in diameter, Flush Mounting. Bakelite Case. Available also in projection mounting. Triplett offers a complete line of 2", 3", 4" and 5" instruments.

Model 521

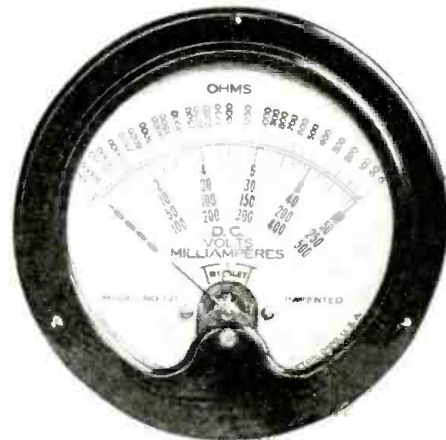

WRITE FOR CATALOGUE—SEE YOUR JOBBER

MAIL COUPON NOW!

Triplett Electrical Instrument Co.
162 Harmon Drive
Bluffton, Ohio

Please rush your new 1936 Catalog.....

I am particularly interested in.....

Name.....

Address.....

City..... State.....

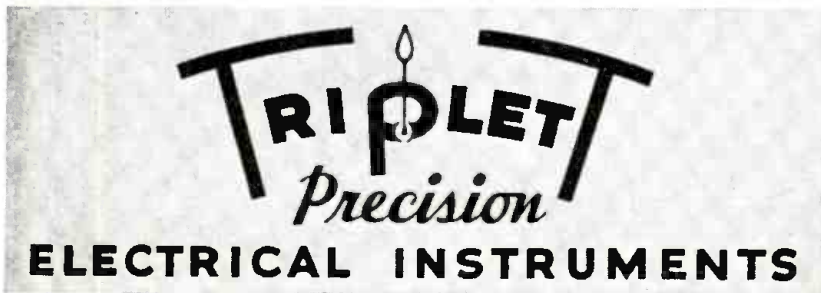

Please Say That You Saw It in RADIO-CRAFT

STROMBERG-CARLSON NOS. 62 AND 63, 8-TUBE HIGH-FIDELITY CHASSIS

(All-wave, 0.54- to 18 mc.; metal tubes; variable-width intermediate; antenna wavetrap; tuning meter [on No. 63]).

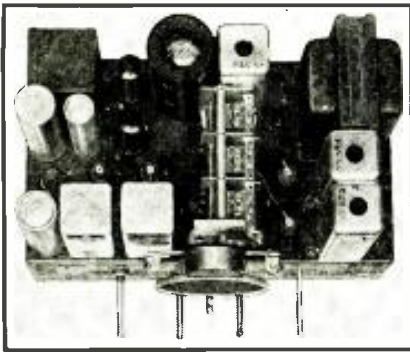

All voltage readings are measured between chassis and ground with a 1,000 ohms-per-volt meter. The line voltage is 120 V. for this table. All filament voltages are 6.3, except for tube V8, which is 4.85 V. The set should be tuned to 1,000 kc. with no signal. The numbers over the columns correspond to the socket term-

inal numbers which are shown on the bottom chassis drawing. Note that there will be no high voltage in the circuit when the speaker plug is removed. The tuning meter is used only on the No. 63 chassis, but the two are otherwise exactly alike. The variable intermediate transformer is used as a band widener for high fidelity.

		TERMINALS							
Tube	Cap	1	2	3	4	5	6	7	8
Type	Conn.								
V1	0	0	-	230	95	3	-	-	3
V2	0	0	-	235	95	0	150	-	3
V3	0	0	-	230	95	3.5	-	-	3.5
V4	-	0	-	0	0	0	-	-	-
V5	0	0	-	25	35	1.5	-	-	1.5
V6	-	0	0	250	260	0	-	0	16
V7	-	0	0	250	260	0	-	0	16
V8	-	428	405	405	428				
Spk.	-	260	400	430	430	260	260		

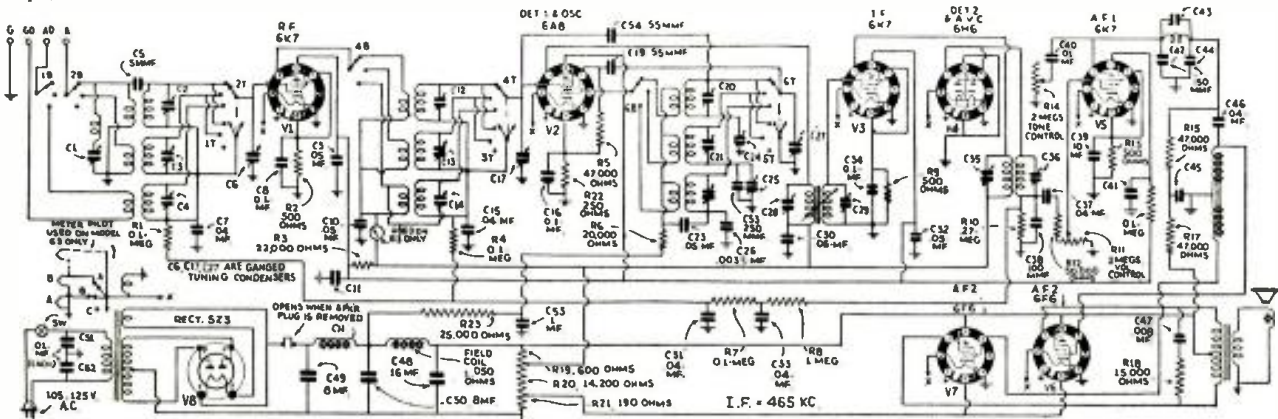
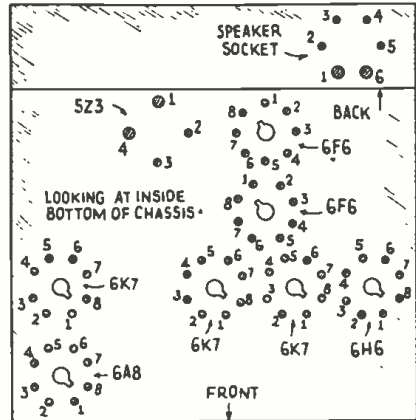
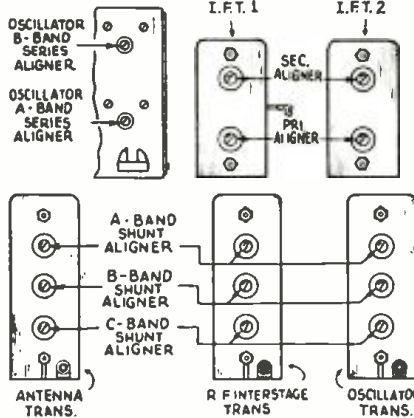

RCA MODEL 103, 4-TUBE A.C. COMPACT DUAL-WAVE SUPERHETERODYNE

(Two bands, 540 to 1,500 kc., and 1,600 to 3,500 kc.; 6-tube performance.)

All necessary voltage information is given on the chassis layout diagram. The I.F. amplifier is aligned by connecting the leads of a service oscillator from cap of V1 to chassis. Tune C11 and C12 for best output. Then feed a 1,400 kc. signal to antenna and ground, set receiver dial to 1,400 kc. and adjust C24 and C25 for highest output. Set oscillator at 600 kc. and align trimmer at rear of chassis. Dial reading of set should fall fairly close to 600 kc. The short-wave band will need

no adjustment. On the latter band the same oscillator coil is employed, a harmonic being used for actual reception. Power transformers are available for either 25- or 60-cycle use. The power output is 1.9W. (undistorted), and 3W. (max.). The power input is 40W. at 115V. Filament circuit is novel in that the pilot light and V3 are connected to one winding, while all the other tubes are in series on another section. (Coil resistances, in parenthesis.) Two of the tubes are of multi-purpose type.

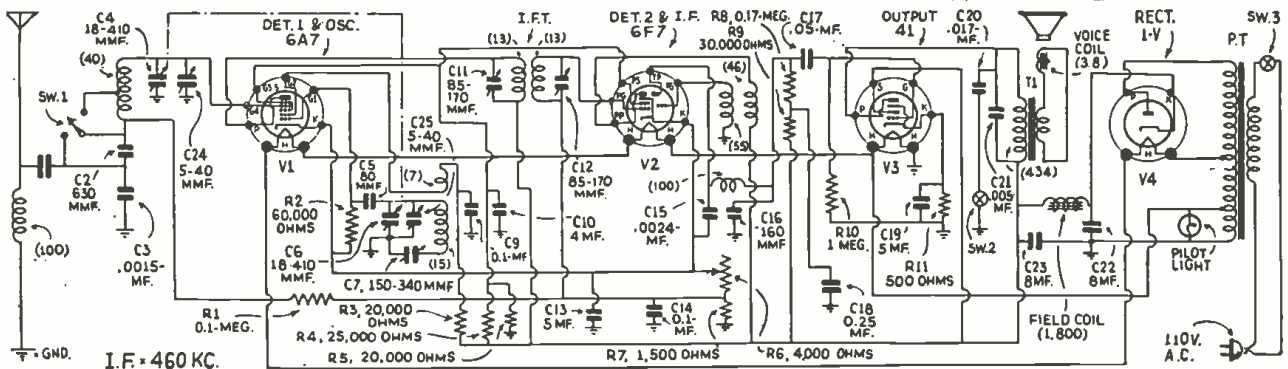
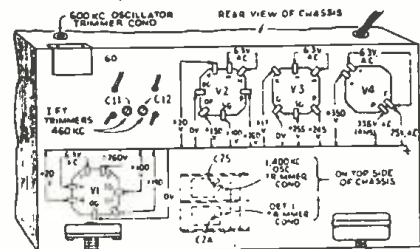

TECHNICIANS' DATA SERVICE

JOSEPH CALCATERRA DIRECTOR

A special arrangement between RADIO-CRAFT magazine and the publishers of this literature, which permits bulk mailings to interested RADIO-CRAFT readers, eliminates the trouble and expense of writing to each individual organization represented in this department.

2. HAMMARLUND 1936 CATALOG. Contains 12 pages of specifications, illustrations and prices on the new line of Hammarlund variable, mid-get, band-spread and adjustable condensers; trimming and padding condensers; R.F. and I.F. transformers, coils and coil forms; sockets, shields, chokes and miscellaneous parts for ultra-short-wave, short-wave and broadcast operation.

3. HOW TO GET A HAMMARLUND 1936 SHORT-WAVE MANUAL. A circular containing a list of contents and description of the new 16-page Hammarlund Short-Wave Manual, which contains construction details, wiring diagrams, and list of parts of 12 of the most popular short-wave receivers of the year.

4. THE "COMET PRO" SHORT-WAVE SUPERHETERODYNES. Describes the outstanding features of the standard and crystal-type Hammarlund "Comet Pro" short-wave superheterodynes designed to meet the exacting demands of professional operators and advanced amateurs for a 15 to 250 meter code and phone receiver, but which can be adapted by anyone for laboratory, newspaper, police, airport and steamship use.

5. ELECTRAD 1936 VOLUME CONTROL AND RESISTOR CATALOG. Contains 12 pages of data on Electrad standard and replacement volume controls. Truvolt adjustable resistors, vitreous wire-wound fixed and adjustable resistors and voltage dividers, precision wire-wound non inductive resistors, center-tapped filament resistors, high-quality attenuators, power (50- and 150-watt) rheostats and other Electrad resistor specialties.

57. RIBBON MICROPHONES AND HOW TO USE THEM. Describes the principles and operating characteristics of the Amperite velocity microphones. Also gives a diagram of an excellent humless A.C. and battery-operated preamplifier.

62. SPRAYBERRY VOLTAGE TABLES. A folder and sample pages giving details of a new 300-page book, containing 1,500 "Voltage Tables" covering receivers manufactured from 1927 to date, published by Frank L. Sprayberry to simplify radio servicing.

64. SUPREME No. 385 AUTOMATIC TESTER. A technical bulletin giving details, circuits and features covering this new Supreme development designed to simplify radio servicing. In addition to the popular features of Supreme analyzers and tube testers it contains many direct-reading features which eliminate guesswork or necessity of referring to charts or tables.

67. PRACTICAL MECHANICS OF RADIO SERVICE. Information, including cost, features and outline of lessons of the Frank L. Sprayberry course in Radio Servicing, and list of Sprayberry Data Sheets for modernizing old radio equipment.

73. HOW TO ELIMINATE RADIO INTERFERENCE. A handy folder which gives very complete information on how to determine and locate the sources of radio noise by means of the Sprague Interference Analyzer. A description of the analyzer and method of using it is included, together with data on how to eliminate interference of various kinds once the source is located.

74. SPRAGUE 1936 ELECTROLYTIC AND PAPER CONDENSER CATALOG. Gives specifications, with list and net prices on a complete line of wet and dry electrolytic, and paper condensers made by the Sprague Products Co. for radio Service Men, set builders, experimenters and engineers. Information on the Sprague Capacity Indicator, for making capacity tests on condensers and in servicing receivers, is included.

75. SPRAGUE TEL-U-HOW CONDENSER GUIDE. A valuable chart, compiled by the Sprague Products Co. which tells the proper types, capacity values and voltages of condensers required in the various circuits of radio receivers and amplifiers, and how to locate radio troubles due to defective condensers. Includes data on condenser calculations.

76. FACTS YOU SHOULD KNOW ABOUT CONDENSERS. A folder, prepared by the Sprague Products Co., which explains the importance of various characteristics of condensers, such as power-factor, leakage, capacity and voltage in determining the efficiency or suitability of a given condenser to provide maximum filtering and safety in operation.

77. SUPREME 391 P.A. ANALYZER. This booklet describes the features and use of the new Supreme 391 P.A. Analyzer, designed to equip the radio Service Men to cash in on the constantly growing opportunities for service in the sound equipment and public address systems used in movie theatres, schools, churches, auditoriums, etc.

A MULTI-TUBE ADAPTER (Correction)

We are in receipt of a correction from the author, Hermie D. Vogel, concerning Fig. 1E of the above article which appeared in July, 1935, page 16. The wire shown dotted should be omitted.

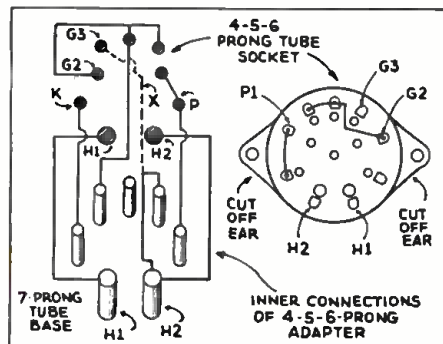

NEW READRITE ALL-WAVE SIGNAL GENERATOR



Uses Plug-in Coils

Five Plug-in Coils cover 5 frequency bands from 100 to 20,000 Kc. All frequencies fundamentals and stabilized. Complete with batteries and two No. 30 tubes.

DEALER NET PRICE ONLY \$14.40

Model 554-A. The new Readrite All-Wave Signal Generator includes all improvements of present-day engineering. The use of plug-in coils permits any new frequency band to be added by a new coil.

Extra wide scale permits accurate frequency settings from the large calibration curves supplied.

Besides having all frequencies fundamentals, this new Signal Generator is complete shielded and tube modulated.

Model 554-A, complete with batteries, two No. 30 tubes and installed in leatherette covered portable case with removable cover.

Dealer Net Price . . . \$14.40

SEE YOUR JOBBER

Readrite manufactures all types of testers used for servicing Radio Sets, including Set Testers, Tube Testers, Resistance, Continuity and Capacity Testers, Point-to-Point Testers and inexpensive Indicating Meters.



THIS COUPON BRINGS FACTS

READRITE METER WORKS,
216 College Drive, Bluffton Ohio

Please send me full information on Model 554-A Readrite All-Wave Signal Generator.....

Catalogue.....

Name.....

Address.....

City..... State.....

Radio-Craft Technicians' Data Service
99 Hudson Street.
New York City, N.Y. RC-236

Please send to me, without charge or obligation, the catalog, booklets, etc. the numbers of which I have circled below.

2	3	4	5	57	62	64
67	73	74	75	76	77	

My radio connection is checked below:

Service Man operating own business.
 Service Man for manufacturer.
 Service Man for jobber.
 Service Man for dealer.
 Service Man for servicing company.
 Dealer.
 Jobber.
 Experimenter.
 Professional Set Builder.
 Amateur Set Builder.
 Short Wave Work.
 Licensed Amateur.
 Station Operator.
 Radio Engineer.
 Laboratory Technician.
 Public Address Worker.
 Manufacturer's Executive.
 Student.

I am a:

Subscriber Newsstand reader

I buy approximately.....of radio material a month. (Please answer without exaggeration or not at all.)

Name.....

Address.....

City..... State.....
(Please print name and address)

Avoid delay. The catalogs and booklets listed are now in stock and will be sent promptly as long as the supply lasts. Please use this coupon in ordering. The use of a letter causes confusion and delay.

Please Say That You Saw It in RADIO-CRAFT

NEW!

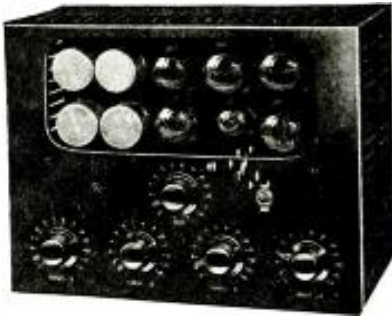

Another
WEBSTER
Chicago
ACHIEVEMENT!

A 4-Position 17-Watt Amplifier

SERVICE MEN! Dealers! Public Address Engineers! You should know all about this latest development of WEBSTER-*Chicago* engineers. It's the **FOUR-POSITION 17-WATT AMPLIFIER**. It is suitable for four crystal microphones or three crystal microphones and one phono input.

Completely Enclosed Unit

This unit is self-contained. Its entire mechanism is in one unit. No pre-amplifier is required. High gain. Output impedance is tapped from 2 to 500 ohms. For multiple microphone and public address systems.

Write today for complete details on the WEBSTER-CHICAGO 4-Position 17-Watt Amplifier . . . also other P. A. Equipment.

THE WEBSTER COMPANY
3825 West Lake Street Chicago, Illinois

There's Only ONE WEBSTER-CHICAGO. It's in Chicago!

EBY
Specializes in
Quality

- Binding Posts
- Tip Jacks
- Male Plugs
- Female Plugs
- Low-Loss Sockets
- A-C Switches
- Tap Switches
- Terminal Strips
- Short Wave Switches
- Moulded Sockets
- Electric Eyes

Write for Latest Bulletin

HUGH H. EBY Inc.
2066 Hunting Park Ave.
PHILADELPHIA, PENNA.

MAKING A 12-TUBE HIGH-FIDELITY BROADCAST RECEIVER

(Continued from page 461)

variable-mu tube, is increased much beyond its normal minimum.) However, it was found that some locals were so powerful that they simply "swamped" the first R.F. tube unless a volume control was placed in the antenna circuit. This was deemed to be an unnecessary complication, so A.V.C. was resorted to as a compromise.

The negative bias voltage applied to each R.F. tube does not exceed 8 or 9 volts on any but stations within a mile or so of the receiver. At this low figure of bias, the amount of distortion in the R.F. amplifier is negligible. The A.V.C. also serves to maintain the R.F. voltage applied to the detector at a nearly constant figure for all local stations. This is important as a diode detector only gives linear rectification when the applied signal is within certain rather narrow limits dictated by the design of the detector circuit. Too low a signal input as well as too great an input to the diode will cause severe distortion.

The output of the diode employs the "split-tapped" load resistor arrangement which allows a pair of push-pull grids to be coupled to the diode without the need of a coupling transformer or phase-inverting tube. The first A.F. stage was connected in push-pull in order to keep second-harmonic distortion at a very low value and also to insure sufficient undistorted power for the grids of the power stage. The inter-stage A.F. transformer is a precision device and will give a response flat within 1/2-db. from 30 to 16,000 cycles.

The power stage employs two 6A3s in class A (not A prime), with a fixed bias source supplied by a separate bias rectifier circuit in the power supply.

The values of bias and plate voltage for the 6A3s in push-pull class A are different from the usual values. The bias is approximately 45 V. The plate voltage is 250. The plate current of each tube should be carefully adjusted so that both tubes balance at 60 ma. per tube. Adjusting the grid bias potentiometers mounted under the chassis serves to balance the plate current of the 6A3s.

The output transformer employed has a primary impedance of 8,000 ohms, plate-to-plate. The secondaries are arranged to feed a 500-ohm device or the voice coil of any speaker from 1.75 to 15 ohms. (Taps are provided on the low-impedance winding to give an exact impedance match to any particular speaker.) The output transformer has a frequency response flat within 1 db. from 30 to 15,000 cycles. The primary winding should be made to carry 60 ma. per leg continuously.

The undistorted output of the amplifier is approximately 10 W. lower than with the "A prime" arrangement but producing much less distortion than the "A prime" system. An output of 10 W. is adequate for ordinary home use; and the lowered distortion makes the drop in power output well worth while in a high-fidelity set.

THE "BASS BOOSTER"

The bass booster is a 2-stage A.F. amplifier which has a peaked frequency response. It is sharply resonant in the neighborhood of 70 cycles. When turned "up" the result is that the bass register is amplified much more than the other frequencies. This device is only for use when the set is playing at low-volume level.

When operated under this condition there is with any receiver not compensated for the effect, a lack of bass response. Reproduction sounds "tinny." The bass booster however restores to a considerable extent the missing bass. It does this by means of an A.V.C. system connected to the power stage. On loud signals the A.V.C. action overbiases the bass booster and there is little amplification. The response of the set is then governed only by the regular amplifier, and substantially flat response is obtained. When volume is turned down to a low level the A.V.C. action decreases the bias on the bass booster and its gain increases, feeding the boosted bass into the regular amplifier and mixing the two to give a frequency response with the bass predominating and thus neutralizing to a considerable degree the low-volume thinness of reproduction.

The mike preamplifier is conventional and needs no discussion. The two transformers in the preamplifier do not have to have as good frequency response as those of the main amplifier unless the use of a high-fidelity microphone for musical pick-up is contemplated. The diodes of the 85 preamplifier tube are used to supply the rectified A.V.C. voltage for the "bass booster."

A concluding article will describe the power supply unit and also give information on the adjustment of the T.R.F. circuits and the "bass booster"; the details concerning the high-fidelity reproducer system, utilizing woofer and tweeter units, also will be given.

LIST OF PARTS

- One I.R.C. resistor, 3,350 ohms, 1/2-W.;
- Two I.R.C. resistors, 50,000 ohms, 1/2-W.;
- Four I.R.C. resistors, 0.5-meg., 1/2-W.;
- Five I.R.C. resistors, 1.0 meg., 1/2-W.;
- Two I.R.C. resistors, .25-meg., 1/2-W.;
- Three I.R.C. resistors, 0.1-meg., 1/2-W.;
- Two I.R.C. resistors, 300 ohms, 1/2-W.;
- Two I.R.C. resistors, 20,000 ohms, 1/2-W.;
- Two I.R.C. resistors, 10,000 ohms, 1/2-W.;
- Two I.R.C. resistors, 2 megs., 1/2-W.;

The chassis layout of the tuner showing positions of parts.

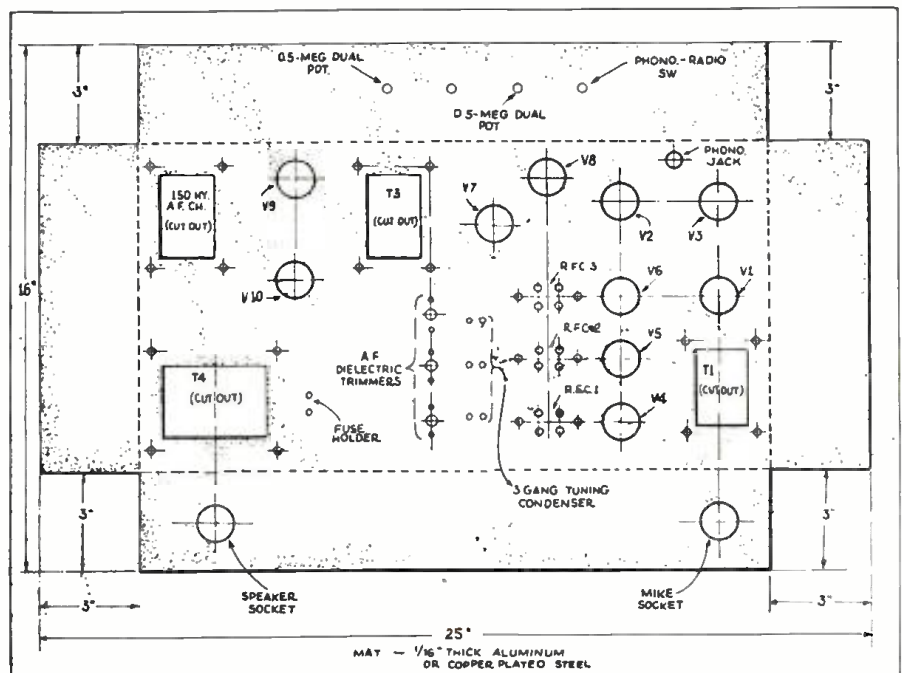

Please Say That You Saw It in RADIO-CRAFT

- One I.R.C. resistor, 2,500 ohms, 1/2-W.;
 - One I.R.C. resistor, 20,000 ohms, 1.0 W.;
 - One I.R.C. resistor, 15,000 ohms, 1/2-W.;
 - One Electrad resistor, with slider, 20,000 ohms, 25 W.;
 - One Electrad resistor, with slider, 5,000 ohms, 25 W.;
 - Two Electrad potentiometers, 50,000 ohms;
 - Two Electrad dual potentiometers, 0.5-meg.;
 - One Electrad dual potentiometer, .25-meg.;
 - One Cornell-Dubilier electrolytic condenser, 25 mf., 25 V.;
 - Three Cornell-Dubilier paper condensers, 1.0 mf., 400 V.;
 - Four Cornell-Dubilier paper condensers, .02-mf., 400 V.;
 - Eleven Cornell-Dubilier paper condensers, 1.5 mf., 200 V.;
 - Fourteen Cornell-Dubilier paper condensers, 0.1-mf., 400 V.;
 - Two Cornell-Dubilier paper condensers, .15-mf., 200 V.;
 - One Cornell-Dubilier paper condenser, 2 mf., 400 V.;
 - One Cornell-Dubilier paper condenser, .05-mf., 400 V.;
 - Three Cornell-Dubilier mica condensers, 100 mmf.;
 - *Three T.R.F. coils, 1,750 to 530 kc.;
 - One 3-kang tuning condenser, 365 mmf. per section;
 - Three Hammarlund air-dielectric trimmer condensers, 50 mmf.;
 - Two A.F. chokes, 30 hy., 30 ma.;
 - *One A.F. choke, 50 hy., 10 ma.;
 - *One A.F. transformer (push-pull plates to push-pull grids), T3;
 - *One output transformer (plate-to-plate—8,000 ohms), T4;
 - *One A.F. transformer (single plate to push-pull grids), T2;
 - *One transformer (tapped primary—500 ohms—to single-grid), T1;
 - One Na-Ald 6-prong special socket (for 6E5);
 - Three Eby 6-prong wafer sockets;
 - Four Eby 7-prong small wafer sockets;
 - Four Eby 5-prong wafer sockets;
 - Two Eby 4-prong wafer sockets;
 - One Raytheon, Sylvania or RCA type 85 tube;
 - Two Raytheon, Sylvania or RCA type 6F7 tubes;
 - Two Raytheon, Sylvania or RCA tube 6D6 tubes;
 - Three Raytheon, Sylvania or RCA type 76 tubes;
 - Two Raytheon, Sylvania or RCA type 6A3 tubes;
 - One Raytheon, Sylvania or RCA type 6E5 cathode-ray tube;
 - *One chassis;
 - *One tuning dial.
- (*Names of manufacturers will be sent upon request.)

OPERATING NOTES

(Continued from page 471)

RCA M-34

THIS receiver is an automotive radio set and this particular instrument was "dead" as far as signals were concerned, only vibrator noise being heard in the loudspeaker. Upon checking the receiver out of the car, tubes and everything checked OK, and stations could be tuned in when a finger was placed upon the aerial plug of the receiver. We decided to put the radio set back in the car and upon doing so found that it was again dead. The aerial plug was then disconnected from its socket, which is fastened to the aerial lead-in, and a finger was placed on the plug after which stations came in fine. The trouble had been in the poor connection between the plug and socket which connect the aerial to the receiver. After this connection was repaired by cleaning the contacts and pressing them tightly together, and then tightening the band which holds the two parts together, the receiver worked like new.

KENNEDY 20B

THE complaint in this set was "distortion and no volume." Upon checking all voltages with the analyzer, I found 275 V. on the plates of the push-pull 45s, the other voltages being normal. Removing the chassis, I checked the voltage divider (which has each section marked in ohms). The 755-ohm section at one end of the voltage divider was open and upon replacing it with a new 750-ohm, 10 W. enameled resistor, the voltage on the 45s became 250 V. and the radio set worked fine.

WAYNE STORCH

This NEW Type of RADIO TRAINING

ACTUALLY SETS YOU UP IN BUSINESS...

... In the Fastest Moving Industry in the World ...

Here, at last, is a NEW and DIFFERENT type of Training that not only teaches you all phases of Radio Service Engineering work—but which equips you for an actual start in business. No matter what kind of Radio training you may take, you will require such materials before you actually enter business. Sprayberry Training gives them to you—teaches you to work with them under actual Service conditions.

Nor is that all. Never forget that there are too many men of only mediocre

ability in ALL lines of business. That is why average wages are low—why many men are out of work. Radio is no exception. But there is always room—there is good pay—at the top of the ladder—and this is where Sprayberry Training is specifically designed to put you. It is for men who take Radio seriously—for those willing to work along sound, intensely practical lines to win a real future in a fascinating industry with vast opportunities for future development.

NO PREVIOUS EXPERIENCE REQUIRED —LEARN AT HOME IN SPARE TIME

Sprayberry Training is really two courses in one. Besides the necessary fundamental teaching it includes the famous Sprayberry Practical Mechanics of Radio Service formerly sold ONLY to men already in Radio—many of whom had found their previous training inadequate for modern Radio needs.

Sprayberry Training has been honestly, conscientiously developed to fit you for a truly worthwhile place in Radio—a place well above the average. It is different from almost any other course you might consider. It is complete—modern—practical. Upon completion, you have both the knowledge

and equipment to enter business then and there for full or part time profits—or to start out in any one of Radio's specialized fields such as sound, broadcasting, etc. Certainly you owe it to your future to investigate—TODAY!



This Complete SERVICE ENGINEERING EQUIPMENT Is Yours!

SPRAYBERRY ACADEMY OF RADIO

2548 University Pl., N.W., WASHINGTON, D.C.

Without cost or obligation on my part please rush complete details of your new type of training and the booklet "My FUTURE IN RADIO."

BEFORE ENROLLING FOR ANY HOME STUDY COURSE, YOU OWE IT TO YOUR FUTURE TO INVESTIGATE THIS ONE.

Name.....

Address..... RC 2/36

STENTORIAN SOUND AMPLIFIER NUCLEUS

REMEMBER! —Build your Amplifier's STENTORIAN way—for powerful, clear volume at low cost. For stadiums, call systems, lodges, banquets, advertising, etc.



NUCLEUS includes "Pull-Push" transformer, chokes, audios, outputs and lettered chassis. 6-10-15-30 watt amplifiers. A, AB power. 2.5, 6.3 v. tubes. Also for mike Pre-Amplifiers; and battery amplifier.

FREE!—Send for full details and illus. bulletin—STENTORIAN Amplifier Nucleus and name of your distributor.

General Transformer Corp.
504 S. Throop St., Chicago
Manufacturers of Replacement Units

CORNELL OIL DUBILIER
MICA PAPER ELECTROLYTIC
The finest guaranteed condensers money can buy.

Write for descriptive catalog No. 128.

CORNELL-DUBILIER CORPORATION
4347 BRONX BOULEVARD
NEW YORK

Please Say That You Saw It in RADIO-CRAFT



-it's a Landslide for CENTRALAB

Every serviceman from coast to coast knows Centralab . . . everybody's his friend and the worst thing his enemies can say is that he's a mighty smooth article. Yes . . . he's smooth all-right . . . and it's that famous non-rubbing contact that makes him "that way."

. . . a tip from campaign headquarters: a mere handful will service practically any set ever made . . . "better than ever before."



Every Radio Service Man should be a member of the Institute of Radio Service Men

Centralab
MILWAUKEE WIS.
RADIOHMS SUPPRESSORS
FIXED RESISTORS

MAKE THIS "RADIO" MOTOR

(Continued from page 464)

side views of the motor. The dimensions of the various parts are not at all critical and will be determined by the size of the permanent magnet available. The iron core for the rotor consists of a piece of iron rod mounted between the magnet poles. The diameter of this iron cylinder should be from 1/2- to 3/8-in. less than the distance between the magnet poles. (A good length for it is half the length of the magnet). Contrary to the usual motor, this core does not rotate but is fixed and the winding rotates around it. (See Fig. 1B)

The only part of the motor where special care must be taken is in the construction of the rotor coil form. A good design for this form is shown in Fig. 1C. It is made of stiff, light cardboard or fibre and care must be taken to see that it is symmetrical. The coil form should clear the iron core by about 1/8-in. on all sides. It will be seen in Fig. 1A that the core is held in place by a pivot which must pass through the bottom of the form. The hole through which this pivot passes should be approximately twice the diameter of the rod.

To the top of the coil form is glued a short length of hard-rubber rod. This rod supports a phonograph needle which serves as the motor shaft. The needle protrudes through the coil form and its point rests in a center-punch mark in the top of the iron cylinder. The top of the hard-rubber rod is hollowed out slightly so that it will hold a few drops of mercury, or it is pivoted at the top with a second phonograph needle as shown in the details of Fig. 1.

The last step in the construction is the winding of the rotor. The more wire used, the better will be the results. The writer used 2,000 turns of A.F. transformer wire, half of it being wound on each side of the hard-rubber rod. One end of the coil is soldered to the phonograph needle and the other end makes contact with the commutator. One of the motor input wires connects to the pivot and the other lightly touches the commutator. The two sections of the coil must be separated on the bottom of the coil form so as not to obstruct the core supporting screw hole. A thin (for lightness) coat of glue on the finished winding will stiffen the whole rotor and make the coil less susceptible to damage.

Figure 2A shows the circuit diagram using a S.P.S.T. switch for making and breaking the current. Figure 2B shows the method of connecting a D.P.D.T. switch which reverses the current at every half-revolution of the rotor and giving twice the power of the method shown in Fig. 2A. With a little ingenuity the builder can design a switch which can be thrown with a very small movement of the hand. If a powerful station is close by, the switch may be eliminated and a commutator built on the hard-rubber rod so that a wire brush makes and breaks contact at the desired time as shown in Figs. 1A and D.

The motor built by the writer has been operated on stations many miles away using the hand commutation method.

(Mr. Hall is connected with the Physics Department of West Virginia University, Morgantown, W. Va.—Editor)

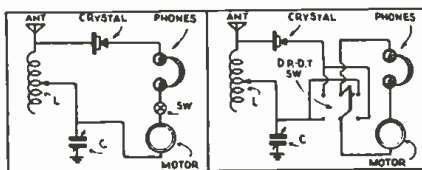

Connections for the crystal motor with single-pole and double-pole switch.

A NOVEL SELF-MATCHING OUTPUT TRANSFORMER

(Continued from page 464)

tions are fractions of an ohm. Use of these combinations is not recommended since the resistance of the secondary winding would enter in to such a great extent that the efficiency of the transformer would be very low (about 60 per cent).

The Service Man usually does not have the facilities for direct measurement of the voice-coil impedance of a speaker. For all practical purposes the impedance of a voice coil is 30

per cent greater than the D.C. resistance. Then to determine the impedance of a voice coil, it is merely necessary to measure the D.C. resistance and multiply this value by 1.3.

A resistance bridge is not necessary for measuring the D.C. resistance of a voice coil. A low-range ohmmeter is sufficient to give the necessary accuracy. The essential parts of such an ohmmeter are: a single dry cell, a 0-1.5A. D.C. ammeter, and a 1-ohm, 3-W. resistor.

For example, let us suppose that a certain voice coil gives a reading of 0.55-A. on the ohmmeter mentioned. The D.C. resistance is then equal to $(1.5 \div 1)$ or 1.73 ohms. Mul-

tiplying 1.73 by 1.3, the impedance is 2.25 ohms. Terminals 4 and 6, from the chart, would then be the correct terminals to which the voice coil should be connected.

In addition to being universal electrically, this output transformer is also universal from a mounting standpoint. It can be mounted on either of two bases, one occupying a space of $1\frac{3}{4} \times 2\frac{1}{2}$ ins. on the chassis and the other, a space of $1\frac{3}{4} \times 2\frac{3}{4}$ ins. Screw hole mounting centers in the former case vary from $1\frac{1}{8} \times \frac{1}{2}$ -in. to $1\frac{1}{8} \times 1\frac{1}{8}$ ins. and in the latter from $1\frac{1}{8} \times \frac{1}{2}$ -in. to $1\frac{1}{8} \times 1\frac{1}{8}$ ins.

Many Service Men have found it to their advantage to carry in their stock one of these versatile transformers because of its adaptability to a large proportion of the radio receivers in use.

This article has been prepared from data supplied by courtesy of General Transformer Corp.

MULTI-PURPOSE SET ANALYZER

(Continued from page 462)

switch.

The R-C tip jacks are used for resistance and capacity measurements. Throwing Sw.5 to D.C. gives a scale of 0-1. ma. at these posts.

A small battery and a variable resistor may then be used as an ohmmeter adapter. (The writer is developing a "free-reference-point" Resistance-Capacity Analyzer, which will be described in an early issue.) Five adapters are required, and should be connected exactly as shown in the diagram, so that the pin connections will be the same as the analyzer sockets. They may be made by bolting adapter sockets on tube bases or adapter bases.

LIST OF PARTS

- One Jewell No. 88, 0-1 ma. meter;
- One Na-Ald No. 456E composite socket 4-5-6 prong, S1;
- One Na-Ald No. 477E socket 7-7 prong, S3;
- One Na-Ald socket 8 prong, S2;
- Two Yaxley No. 422 tip jacks, TC;
- Two Yaxley No. 422 tip jacks, test leads;
- Two Yaxley No. 422 tip jacks, R-C leads;
- Four S.P.D.T. toggle switches, Sw.1, Sw.2, Sw.9, Sw.10;
- One D.P.D.T. toggle switch, Sw.3;
- One Yaxley No. 762 jack switch, Sw.4;
- One Yaxley No. 763 jack switch, Sw.5;
- Two Readrite No. 27 rotary switches, Sw.7, Sw.8;
- One Readrite No. 34 rotary switch, Sw.6;
- Two Electrad meter shunts, 500 ohms, R1;
- One Electrad meter shunt, 55 ohms, R2;
- One Electrad meter shunt, 10 ohms, R3;
- One Electrad meter shunt, 5 ohms, R4;
- One Weston 10-A. meter shunt, R11;
- One Shallcross multiplier resistor, 4,970 ohms (unwind 30 ohms from 5,000 ohm precision resistor), R5;
- One Continental Carbon multiplier resistor, 5,000 ohms, R6;
- One Continental Carbon multiplier resistor, 90,000 ohms, R7;
- One Continental Carbon multiplier resistor, 0.4-meg., R8;
- One Continental Carbon multiplier resistor, 0.5-meg., R9;
- One Aerovox multiplier resistor, 4,500 ohms (unwind 500 ohms from 5,000 ohm precision resistor), R10;
- One Taurex meter rectifier, RX;
- One bakelite panel, 7 x 9 ins.;
- One analyzer cable, 9 wires;
- One dual S.G. cap and lead;
- Three Radio City 1 1/4-in. pointer knobs;
- Five 7-hole 4-5-6-7S and 8-prong adapter sockets;
- Five 4-, 5-, 6-, 7S- and 8-prong adapter bases.

AMPERITE HIGH LEVEL VELOCITY

Operates WITHOUT PRE-AMP HIGH IMPEDANCE—2000 OHMS THIS MICROPHONE IS HIGH ENOUGH IN IMPEDANCE TO OPERATE DIRECTLY INTO GRID . . . BUT NOT HIGH ENOUGH (ONLY 2000 OHMS) TO INTRODUCE SERIOUS LOSSES IN LINE UP TO 200.

Replaces condenser and crystal mikes. No changes necessary. Eliminates input transformer and its losses. Eliminates hum trouble and feedback.



ELIMINATES HUM TROUBLE

MODEL RB-H. for speech and music. LIST \$42.00 with coupling. MODEL RS-H. for speech, but can also be used for music. LIST \$32.00 with coupling. Write for Bulletin H.

New! POSITIVE-AND-SMOOTH-ACTION STANDS

Positive, non-sliding, ball-bearing clutch! Will never wear out never require adjustment. WILL NOT "CREEP". Tightens with only 1/8 turn of clutch. Mike can be rotated without loosening clutch. SMOOTH, PNEUMATIC-LIKE ACTION up and down. A model for every purpose. WRITE FOR ILLUSTRATED BULLETIN S.



AMPERITE Company 561 BROADWAY NEW YORK

AMPERITE "DOWN" Velocity **MICROPHONE**

If you are interested in servicing electric refrigerators, turn to page 505 of this issue and read the advertisement on the second volume of the OFFICIAL REFRIGERATION SERVICE MANUAL.

Please Say That You Saw It in RADIO-CRAFT

MILESTONES IN BROADCASTING

(Continued from page 457)

According to *Radio Retailing*, however, 57 per cent of all receivers now offered use regular glass tubes. About 16 per cent of all sets at present on the market are equipped with glass tubes, but having a metal-tube socket, another 16 per cent use both metal and glass tubes in the same chassis, and 11 per cent exclusively use metal tubes.

Since the public quite definitely is "sold" on metal tubes these statistics may change tremendously; after all, public opinion is a powerful force that no manufacturer dare ignore if he wants to stay in business. Although many radio dealers interviewed by the author report a heavy demand for metal tubes, some of these dealers—and, especially, those who had sold metal-tube sets equipped with early models of the new tube—because of the trouble with their customers concerning radio receivers which did not work satisfactorily, are quite biased against metal tubes. But this by no means indicates a permanent antagonism toward metal tubes.

METAL TUBES MUST GET OLDER

It took about 20 years to develop the glass tube into the precise operating devices we know today, and the metal tubes, even if we include the two or three years of experimenting before they were introduced, still are quite young products, and have plenty of time to be improved before reaching the age of glass tubes. Then again, 90 per cent more types of tubes are now available in glass than in metal; and of all those most instable yet economical and highly-perfected of tubes—the "multi-purpose" type, only one model, the new 6Q7, is so far available in metal. However, the tube situation changes daily in favor of the metal tubes, as may be seen from another diagram published recently by *Radio Retailing* (see Figs. 2B and C).

In the diagram Figs. 2B and C, only 39 radio set manufacturers are mentioned as users of metal tubes against 47 claimed in the advertising described above; this is due to selection of only the more important concerns among the 115 American radio set manufacturers. A still better view of the actual situation is given by the following, Table II, published recently by the magazine *Fortune*, which indicates how the leading manufacturers ranked in 1934 with respect to set sales.

TABLE II

Proportion of units produced by manufacturers.	
Philco	1,250,000
RCA	500,000
Crosley	300,000
General Household Utilities	300,000
(mostly automobile radio sets)	
Colonial	300,000
(mostly for Sears, Roebuck)	
Wells-Gardner	200,000
(mostly for Montgomery Ward)	
Emerson	200,000
(mostly midget)	
G.E.	200,000
(made by RCA)	
Atwater Kent	100,000
Zenith	100,000
Bosch	100,000
Total accounted for	3,550,000

During the year 1934 there have been produced and sold (including 612,000 radio receivers exported)—4,696,000 radio sets. Since the percentage of sales made by the different manufacturers during 1935 probably is about equal to their percentage of sales during 1934, the advertisement which printed the names of 47 different manufacturers, and disregards their yearly output appears in quite a different light.

READERS' DEPARTMENT

(Continued from page 465)

playing their outfits and hoping the Association will not catch up with them. Even these would pay if the fee were more reasonable.

I hope you will print this so that other Service Men will send in their views.

W. R. LUSTIN.

Thanks very much for your comment, Mr. Lustin, a little publicity regarding this situation may help.

INTERNATIONAL RADIO REVIEW

(Continued from page 466)

waveform distortion introduced by the shielding cage. This aerial offers possibilities for the experimentally-inclined fans.

A NEW TABLE-MODEL SET

THE EXPRESSION *table model* has become firmly associated with small sets designed to rest on a table, but in the true sense of the word a table-model set would be one with the set mounted in a table!

Such a set was described in an issue of *Wireless World* (London) a short time ago. As shown in Fig. B, the set (a superheterodyne) is housed within a drawer of the table, with the speaker (mounted behind the chassis) facing forward and downward in such a way that closing the drawer does not affect the sound. The piece resembles a serving table with two wings which fold down flat against the sides.

THE TELEPHONE-DIAL SET

A NEW German set which made its appearance at the Berlin Radio Show is equipped with a novel type of tuning dial, in the form of a revolving dial disc similar to the dials used in automatic telephone systems. Tuning in this set (Fig. C) which was described in *Radio-Handler* (Berlin) is accomplished by dialing to a predetermined number. For example, London—74, Berlin—42, Rome—29, etc. Thus, to tune in London the listener turns the dial first to 7, then to 4.

A BOOK-CASE SET

ANOTHER novelty in set design is made to imitate a group of books which can be set on a table between bookends. This set, shown in Fig. D, is of French origin.

A glance at the photo shows that the speaker "horn" is located below the tuning controls. When the set is opened for use, the front drop-panel forms a horn-type projector for the small-size speaker.

A HIGH-FIDELITY PHONO.-RADIO

A NEW German receiver of odd appearance was introduced recently and is shown in the photo here (see Fig. E).

The receiver is a 5-tube superheterodyne which has a variable band-width adjustment for fidelity control. The set uses 2 dynamic speakers, one for the bass and middle register and the other, a tweeter, for high-frequency response.

A phonograph pickup and turntable are mounted just below the tuning controls, within the "control compartment" at the back of the desk.

(This set sells for about \$280.)

AN UNUSUAL FRENCH SET

A RECENT issue of *La T.S.F. Pour Tous* (Paris) contained a photo of a peculiarly-shaped cabinet which will interest many American radio enthusiasts.

As shown in Fig. F, the cabinet has an irregular, hexagonal shape with the tuning dial on the front facet. On this side also are mounted a tuning indicator, a volume control and tone control. On the adjacent facets, to left and right, are 2 speaker grilles, behind which are mounted the 2 speakers. The other three sides complete the cabinet structure.

A shallow lid covers the phonograph equipment when not in use.

A NOVEL RADIO-PHONOGRAPH

THE magazine *L'Antenne* (Paris) recently contained several views of the novel radio-phonograph unit shown in Fig. G. The cabinet is cylindrical in shape, with the radio set at the top and the automatic record changer and record storage cabinet in the bottom. Two doors in the front provide access to the phonograph unit. Receivers are available both in A.C. and A.C.-D.C. types.

(Unusual cabinet styles are featured much more in Europe than in this country, as shown by this issue, and other examples in past issues of *Radio-Craft*.)

"YOUR NEW BOOK HAS PUT MONEY IN MY POCKET!"



FREE!
Send for Your
Copy Today

● SERVICEMEN write us that Sylvania's new volume of Service Hints can't be beat. Send for your FREE copy today.

Sylvania's new book Service Hints contains practical servicing tips that have been gathered from successful servicemen all over the country.

You get the benefit of their years of experience when you tackle tough problems. It gives you the easiest solution to everyday problems. These and hundreds of other up-to-the-minute service tips are contained in Sylvania's new book Service Hints. Send for this valuable book today, and put yourself in line for more and better service jobs with bigger profits.

Get the inside dope on receiver troubles. Iron out your problems. Right now... fill out this coupon and send it to the Hygrade Sylvania Corporation. The New Volume of Service Hints will be sent you within a few days.

Hygrade Sylvania Corporation.
Makers of Sylvania Radio Tubes and Hygrade Lamps. Factories at Emporium, Pa., Salem, Mass., and St. Mary's, Pa.

SYLVANIA

THE SET-TESTED RADIO TUBE
© Hygrade Sylvania Corp. 1936

Hygrade Sylvania Corporation
Emporium, Pa. RC-2

Please send me free, without obligation, Volume 2 of Sylvania's "Service Hints".

Experimenter Amateur Call.....
 Serviceman Employed by dealer
 Independent

Member Service Organization.....

NAME

ADDRESS

CITY..... STATE.....

NAME OF JOBBER.....

ADDRESS

Please Say That You Saw It in RADIO-CRAFT

Servicemen!



Let Me Help You Build a **REAL SUCCESS**

Naturally, I don't claim that EVERY serviceman who has taken Sprayberry training is making "big money." But taken by and large, you'll find Sprayberry graduates forging ahead far more rapidly than competitors who drift along, relying solely on their own resources and ideas.

In almost every case, a modest investment in Sprayberry training has netted handsome dividends. Dozens of enthusiastic letters prove this.

GET ALL THE FACTS!

Let me tell you about this modern course designed exclusively for forward-looking servicemen. This information will cost you nothing and, as it has already done for so many others, may point the way to a better, brighter future in the work to which you are devoting your life. Send the coupon NOW!

F. L. SPRAYBERRY, 2548 University Pl., N. W., Washington, D. C.

Without cost or obligation, please send your book "PUTTING PROFITS AND EFFICIENCY INTO SERVICING."

Name _____

Street _____

Address _____ RC2/36

SPRAYBERRY'S PRACTICAL MECHANICS OF RADIO SERVICE

WRIGHT-DECOSTER Port-A-Case



Model 890

This handsome ruggedly constructed carrying case complete with a large Model 790 -10" D.C. Wright-Decoster Speaker

For Only **\$14.40** list OR

Make it an A.C. Speaker by using a Model 470 field supply at the low additional list price of **\$4.70**

There is plenty of extra room in the Port-A-Case for the field supply and a small amplifier besides.

Write for catalog giving full description and showing our astonishing prices for the Port-A-Case Complete with the different 12" Speakers.

Remember the quality always remains the same

Buy through the Wright-Decoster distributors. You will find them always anxious to cooperate.

WRIGHT-DECOSTER, Inc.
2251 University Ave. St. Paul, Minn.

WAR-TIME USES OF RADIO

(Continued from page 467)

found itself encircled by English battleships! These stations, equipped with very selective and extremely sensitive receivers, were able to receive communications transmitted from ship to ship, while the German High Sea Fleet was still lying at anchor at its base at Wilhelmshaven.

Although the cautious Germans used tiny buzzer transmitters for these communications, super-sensitive receivers at the English "SWS" (Shore Wireless Station) posts were able to receive these important communications. (Some of the receivers employed as many as 20 tuned R.F. stages in cascade, all simultaneously operated by a single control (or "joy-stick" as it was popularly termed).

LOCATING SUBMARINES AND ZEPPELINS

These SWS stations (erected and operated by the English Intelligence Service) also employed excellently-functioning *direction-finding* devices. German submarines which sent their reports by radio to their base and received instructions by the same means were under constant surveillance by crews at the SWS stations. Experienced observers were able to recognize a certain submarine or airship, even when it changed its call signal, by peculiarities in the tone of its transmitter or by a characteristic dash in the sending of its operator. An extra-long dash, or a skipped dot accounted for the detection of many submarines, which otherwise might have gone unrecognized for a long time. The Intelligence Service would endeavor to decipher the coded messages, while the staff of the direction-finder squads plotted the exact position of the submarine under surveillance. This knowledge of the submarine's exact position enabled the necessary action to be taken, in order to destroy it, and thus avoid the threatened cutting off of England's food supply.

A particularly exciting job for the staff of the SWS stations was the detection of Zeppelins before and during a raid over England, especially towards the end.

When these great airships were attacked, and in adversity, their distress signals in many instances were transmitted in a condition of agitation which left only a feeling of pity for the brave Zeppelin operators who must have known that in a few minutes their lives would be lost.

All this excellent radio work between 1914 and 1918 was accomplished in spite of limited knowledge concerning amplification by electron tubes. Since then, radio technique has made tremendous strides, and superb equipment is available today for signal interception and direction finding.

But since the war many fundamentals of war tactics, and also many methods of applying radio communication have been changed and improved, and even at the present time there is discussion among militarists about further improvement of war tactics. But regardless of the opinion of the different groups which favor the "dynamic tactic" (tanks, armored cars, etc.) or of the countergroup which is in favor of the "static method of fighting a war" (trenches, etc.), all of them recognize the importance of a properly functioning communication system.

(A favorite trick to confuse the adversary

Direction finding and radio outfit of the Berlin Airport. The officer on the left turns the loop antenna mounted above the roof. The officer on right tunes the aircraft receiver. The receiver shown in the center is installed in a cast-iron cabinet and covers the wave range from 15 to 30,000 meters.



was to send out powerful, broadly-tuned signals that interfered with regular messages by producing an unintelligible "hash" at the receiver—"jamming the ether" it was called.

Present advices seem to indicate that the new Armstrong system of amplitude-modulated transmission will prevent such "jamming" of signals, in future.)

WAR GAMES INDICATE RADIO LIMITATIONS

To what an extent radio communication is applied today in modern warfare is indicated by the fact that during the great Fall maneuvers of 1935 in upper New York State, 268 short-wave transmitters were employed by the U.S. Signal Corps to transmit and receive the commands directly or indirectly sent by the main station at the headquarters in Pine Camp. If we consider the small area which was selected by the General Staff for this struggle between the RED and the BLUE armies the tremendously difficult task of the radio operators of picking out the assigned wavelength from the great wave mixture is easy to understand.

Generals who have a reputation of always asking technicians for the solution of seemingly impossible problems (and—strange as it may seem—always getting their wishes fulfilled in the course of time) had their own opinions about these maneuvers, and about the operation of a great many radio stations in a relatively small sector.

SAYS GENERAL FOX CONNER:

General Fox Conner (commander of the First Army) for example, at the end of these field maneuvers, made some caustic comments about the efficiency of radio communication for war purposes. The General stated in part: "Personally, I think we have gone perfectly wild on the subject of radio. We are spending an awful lot of money on radio, I think it should be cut out and spent on laboratory work for development of telephony and other forms of communication."

These comments of General Conner, who is known to be one of our most able army leaders aroused a great deal of discussion among radio enthusiasts, since radio seemed to them as valuable to a modern army as airplanes and tanks. The radio industry, however, kept absolutely quiet concerning these remarks, and it was only some sarcastically-inclined radio engineers who could not refrain from pointing out that the Army could hardly blame the airplane industry for their misfortune during the fight over air-mail contracts, merely because private organizations did the job much more efficiently.

Instead, this experience with the air-mail contract fight has renewed the lesson of the great war—that the army is not responsible for its misfortunes, even the best pilot cannot fight against nature, since the air weapon is very much dependent on weather, an experience also confirmed by the last maneuvers in England and France. But the air weapon is not alone in having limitations: the seemingly invincible tanks also are limited in their use.

A bitter lesson in this respect was recently received by the Italians who saw their "carro veloce" (a medium-heavy type of tank, equipped with especially heavy machine guns), made defenseless through the use of quite simply-constructed lion traps. We know furthermore from statistics that of 100 soldiers poisoned by gas only 1.73 have died against 24.65 per cent of those who were wounded by other weapons. We know also that a great many soldiers killed by gas were members of the army which applied the gas (because of change of wind, etc.). If all these modern implements of war have their limitations, then how can we expect perfection from radio?

General Fox Conner may be right in his criticism if he condemns the *exclusive* use of radio as a means of communication. It is a recognized fact that the so-called "Schrott effect" and the "thermal agitation" limit the sensitivity and thus the efficiency of a receiver. Also, the selectivity is limited by the demand of the armies that their stations must be easy to operate and light in weight. Therefore, it is not the technicians but physical phenomena such as snow, rain and thunderstorms which interject their veto against the desires of Generals. No reasonable radio technician denies the important role of the telephone in war, but still there are some new means of radio communication in development which may be very useful as substitutes for telephony by wire.

Please Say That You Saw It in RADIO-CRAFT

DECIMETER WAVES

As reports from Europe indicate, the English, German and Italian armies are at present very busy with experiments on wavelengths below 1 meter. These wavelengths (often termed "decimeter waves") are limited to a range that extends only the distance which the eye unobstructed by earth curvature, etc., can see.

These waves have the additional advantage that a tremendous number of these ultra-ultra-short-wave transmitters can be operated very close to one another without any mutual disturbance. Interception or interference is possible only by cutting in the straight line between transmitter and receiver, and even if this were accomplished the interception could be detected at once due to fading caused by the "electrical shadow" of the interceptor. Even though some of the frightful stories distributed by the Italians about these decimeter waves are not true, it is nevertheless sufficiently promising for the army to pay much attention to decimeter waves.

GENERAL HARBORD ON WAR-TIME RADIO

What Generals (who are not disappointed by the results of army maneuvers) think at a time of calm about radio may be learned from part of a statement made by General Harbord, who said: "For one great problem which had before never arisen in any big war, radio supplied a solution which could not have been offered by any other means of communication now known—that was, in providing contact between aircraft in flight and the ground. The commander can send aloft observers before whom distant battle-grounds lie revealed as the smaller fields of antiquity were to the man on a high hill. But the use of the invaluable knowledge which the observer may have gained usually depends upon its instantaneous transmission to his commander.

MODERN WAR RADIO DEVICES

Since mobility therefore is one of the fundamental demands asked of radio stations to be used by the army, the light-weight radio unit is the standard equipment of all armies. Most of these radio stations used at present are of the so-called knapsack type. One box contains the transmitter, a second one the aerial supports and the antenna wires. The current source is often a pedal generator also transportable like a knapsack. It takes only a few minutes to make such a station ready for operation, and even less time to make it again transportable. In addition to these universal stations with very large wave ranges there are also short-wave stations in use. Most of these are crystal controlled, with a simple switch to change wave range and crystals. A tiny antenna, often of the umbrella type, is used for reception and transmission. These stations are light enough to be carried by one man. A small box containing an Edison storage battery, and a high-voltage dry battery are used as current sources. The station is carried on the back with the small battery box in one hand.

Some of the most interesting post wartime developments are the new antennas used by submarines for radio transmission while the boat is under the sea level. Despite the fact that this seems quite contrary to all that we know about the propagation of radio waves, according to a dispatch from London to the *New York Times*, the new German submarines recently put in use are equipped with such antennas.

At the second Annual Marine Exhibition in New York, November 1935, a new receiving apparatus for the reception of weather maps, printed matter, etc., was displayed by RCA to be used for the transmission of radio facsimile to flying airplanes or ships at sea. There also are available in Europe radio facsimile transmitting units of special, light-weight design for use in airplanes to instantly send to the ground maps and photos made in the airplane.

REMOTE CONTROL

Remote control by radio has been demonstrated and was even actually applied during the World War. Since it is today a general custom to send commands to tanks, airplanes, battleships, etc., by means of radio, it does not seem fantastic that some day not only torpedoes, but also all types of mobile craft will be directed by radio, replacing the human brain with an electro-mechanical one. Many seemingly impossible devices are still in development, others of which we do not even dare think may be ready for practical application, tomorrow.

The DIRECT-CONTACT, CARBON VOLUME CONTROL With ONLY ONE MOVING UNIT

SIMPLICITY is the keynote of Electrad design—simplicity which performs efficiently without waste motions.

Direct floating contact on the carbon resistance element, with only one moving unit in the entire assembly, mean freedom from mechanical complications, longer life and more positive, finer variation of current regulation.

The resistance element is permanently fused to the flat outer rim of a warp-and-wobble-proof Bakelite ring. The special-alloy floating contact is self-cleaning—polishes the carbon to icy smoothness—keeps it clear of dust. No skipping, leaping or stuttering to make noise.

Electrad individually tests each volume control for noise before it leaves the factory, and unqualifiedly guarantees trouble-free performance. Use an Electrad in your next service job.



Complete mechanism of the control, showing straight-path travel of contact shoe on resistance element.



Complete control, showing new type power switch interchangeable with standard end cover.

RESISTOR SPECIALISTS
Featuring:— Quiet Carbon Volume Controls, Vitreous Resistors, Truvolt Resistors and Power Rheostats.

Write Dept. RC-2 for New Catalog

New 100-Page VOLUME CONTROL GUIDE

FREE, if you send us the flap (part showing specification and resistance) from any new-type Electrad Carbon Volume Control carton, together with your business letterhead or card.



Address: Dept. RC-2

6 1/2" x 9 1/2"



These Splendid Books FREE!

Think of it! 2 books full of invaluable information, to be had for just the mailing costs! One with 20 complete transmitter designs including 12 tested transmitter RF section designs and 8 modulator and speech amplifier designs. Circuits, complete parts specifications, inductances, etc. all included.

Ten complete designs for public address amplifiers in the other book. It includes one for every purpose, from 3 Watts to 30 Watts output, with complete parts lists for each.

These books should be in every amateur's technical library. They are invaluable for reference purposes. Just 22 cents in stamps brings them both to you. Send for your copies today.



STANDARD TRANSFORMER CORP.

856 Blackhawk Street,

Chicago, Illinois

MAIL THIS COUPON!

STANDARD TRANSFORMER CORPORATION,
Dept. C, 856 Blackhawk Street, Chicago, Ill.
I am enclosing 12c for Transmitter Manual.
I am enclosing 10c for Amplifier Manual.

Name _____ Address _____
City _____ State _____



Please Say That You Saw It in RADIO-CRAFT

GRASP IT—SERVICE DEALERS!

1936 OPPORTUNITY TO OWN FINE SHOP EQUIPMENT FREE OFFERED BY NATIONAL UNION



RESOLVE NOW

To take advantage of National Union free shop equipment offers. Remember, when you handle National Union radio tubes you get the benefit of a superior quality product plus premiums of fine modern service instruments.

**NATIONAL UNION RADIO CORP. OF NEW YORK
570 LEXINGTON AVENUE, NEW YORK, N. Y.**

What is your special equipment opportunity for 1936?

Name.....

Street.....

City..... State..... RC-226

Train Now for New RADIO Opportunities



Get Into a Line Where There's Action—Every Day—And a Payday Every Week—You Be the Boss!

Right now while hundreds are looking for work where there isn't any, the radio service field can use trained men. With the proper training and the necessary equipment, you can enter this field and make a comfortable living. We include with our course this modern set analyzer and trouble shooter without any extra charge. This piece of equipment has proved to be a valuable help to our members. After a brief period of training you can take the set analyzer out on service calls and really compete with "old timers." We show you how to wire shortwave receivers—analyze and repair all types of radio sets—and many other profitable jobs can be yours. Teaching you this interesting work is our business and we learn quickly yet thoroughly. If you possess average intelligence and the desire to make real progress on your own merits, you will be interested.

Analyzer & Resistance Tester—Latest Design—YOURS Without Extra Cost

ACT NOW—MAIL COUPON

Start this very minute! Send for full details of our Plan and free booklet that explains how easily you can now cash in on radio quickly. Don't put it off! Write today. **SEND NOW!**

RADIO TRAINING ASSN. OF AMERICA
Dept. RC-62, 4513 Ravenswood Ave., Chicago, Ill.

Gentlemen: Send me details of your Enrollment Plan and information on how to learn to make real money in radio quick.

Name.....

Address.....

City..... State.....

TESTING METAL-TUBES SETS WITH PRESENT EQUIPMENT

(Continued from page 463)

ADAPTING ANALYZER TO SET

Most analyzers can easily be modified to test receivers using metal tubes. This can be done by using two adapters. One fits onto the plug ordinarily inserted into the receiver socket. Figure 1B shows this adapter which is used with a 7-prong plug and fits into the octal socket regardless of the number of base pins the tube has.

The adapter allows the ordinary 7-prong plug to fit into the octal socket. Note that no connection can be made to chassis through the shield pin contact, since we do not have an 8th pin or a 9th wire in the cable. This ground connection is not essential in testing.

ADAPTING TUBES TO ANALYZER

We now have the analyzer connected to the receiver using metal tubes. Now we have to connect the metal tube to the analyzer. This can also be done with an adapter. An adapter is on the market, which will plug into a standard 7-prong socket and an octal base tube will fit into the adapter. This adapter is shown in Fig. 1A. This adapter will take any octal-base tube regardless of the number of base pins.

This is the simplest method and merely requires the purchase of two adapters. A more satisfactory way will be to purchase a 9-wire cable and adapters. Eight wires of the 9-wire cable are connected to the corresponding former contacts of the 8-wire cable. The 9th wire should then be connected to a tip-jack. If the analyzer has a ground or a chassis connection, connect this wire to this ground connection. Otherwise mount a special tip-jack at some convenient point for this connection.

The 9-wire cable should be connected to an octal-base plug which will fit directly into metal-tube sockets.

Adapters will then be used to connect the plug into ordinary 4-, 5-, 6- and 7-prong sockets.

If your analyzer is of the type which has a socket on its panel for plugging the analyzer cable in, instead of connecting the wires direct to the sockets, the plug and socket should be changed to the octal-base type.

An adapter will also have to be used to plug the octal-base tube into the 7-hole socket of the analyzer. (If room permits, an 8-prong socket may be used to eliminate this adapter.)

Another difference in the metal tubes is in the arrangement of the base pins. The tubes have been constructed so that they will all fit in the 8-prong socket, even though the tube has only 5 prongs. See Figs. 1C and D. Figure 1B shows the base pin arrangement for the 6A8; Fig. 1A, the base pin arrangement for the 6C5. Both drawings are bottom views. Notice that both tubes will fit in the same socket, the 6A8 having a prong for all 8 holes. The 6C5 will fit in the same socket, but two pin holes will be empty.

This makes a universal numbering arrangement possible. This must be remembered when testing these circuits. Otherwise you may not connect your meter to the desired circuit. You will find the heater and cathode connections for these tubes to be the same with very few exceptions. However, the plate and grid connections vary with nearly every tube. You will have to consult the tube base connections for each type tube when testing these circuits. This will, of course, require a free point-to-point analyzer.

These tubes also have a smaller control-grid connection on the top of the tube. However, clips may be secured which will fit either tube. You can also get clips for connecting the clip from the set to your analyzer plug.

These are the main differences you will notice in the physical construction of the tubes. However, the interior elements have been improved to some extent. Although some of the metal tubes are very similar to glass tubes which have been manufactured for some time.

These changes in tube characteristics are going to give you some changes in readings while testing these circuits.

6H6 TESTING DATA

There are two tubes, and one in particular, which are quite different from any tubes made before. The first is the duo-diode 6H6. It is practically the same as former diode tubes, ex-

cept that it does not have a triode or pentode section in the same envelope. Also there is a separate cathode for each diode, while previously these diodes have had a common cathode; remember this, since in many circuits using this tube, the cathodes are not connected together.

One manufacturer uses this tube as a full-wave rectifier for the detector. In some models, this is used also for A.V.C. action, and in others, a second 6H6 is used for A.V.C. The latter idea is shown in Fig. 1E.

Another manufacturer uses one diode for detector and A.V.C. and the second diode to furnish bias for the controlled tubes when tuned to a weak station or to no station. This circuit is shown in Fig. 1F.

6L7 TESTING DATA

The other tube is the 6L7. It is the biggest change from the older-type tubes. It has been designed as a first-detector, using a separate oscillator. This tube has two control-grids which will affect the plate current. However, these control-grids are shielded (by an interposed grid) from each other. A typical circuit is shown in Fig. 1G.

Testing this tube as a first-detector will not vary much from your tests of a 6A7 or 6A8. However, this tube is likely to be used in many unusual circuits. Due to these two separate control-grids, this tube will have many uses. It may be used very effectively as an R.F. amplifier with the second grid for A.V.C. This might mislead you while testing the circuit.

This article has been prepared from data supplied by courtesy of Sprayberry's Practical Mechanics of Radio Service.

2 NEW METAL TUBES

(Continued from page 463)

6Q7

The triode-section is a high- μ tube designed for resistance coupling. The coupling resistance may be any value up to approximately $\frac{1}{4}$ -meg.

The two diode units are independent of each other and the triode unit (except for the common cathode sleeve). The diode units may be used either as a half-wave or full-wave rectifier, or a half-wave rectifier with the other unit used for delayed A.V.C.

The same external plate resistance values may be used with the 6Q7 tube as with the type 75 tube. The bias should be about $\frac{1}{2}$ -V. more with a 250 V. supply and $\frac{1}{4}$ -V. more with a 100 V. supply than would be used with the type 75 tube (shell tied to the cathode or ground).

(Continued from page 463)

OZ4

and filtering commonly used to eliminate vibrator noise will usually be sufficient.

The OZ4 is filled with a permanent gas rather than a vapor filling. The tube characteristics are independent of the surrounding temperature.

The OZ4 has the same external form and dimensions as other tubes of the metal line. However, in this tube the metal shell serves chiefly as container and electrostatic shield for the glass bulb, which is required to insulate the contained gas from the grounded shell.

Leading manufacturers of vibrator-"B" units for car-radio receivers are enthusiastic about the performance of the OZ4 in service tests which have been running for several months. It is said that synchronous vibrator rectifier efficiency can be had with the OZ4 and a simple non-synchronous rectifier.

The OZ4 is rugged and has no filament to break or burn out. It is expected to simplify the power supply problem for many car-radio set receiver manufacturers during the coming season. The base of this tube is a standard octal type.

Operating Conditions and Characteristics

D.C. output voltage	300 max.
D.C. output current, ma.....	30 min. 75 max.
Peak plate current, ma.....	200 max.
Starting voltage	300 min.
Voltage drop (dynamic).....	24v'g.

This article has been prepared from data supplied by courtesy of Raytheon Production Corp.

Please Say That You Saw It in RADIO-CRAFT

THE RENODE A NEW GRIDLESS TUBE

(Continued from page 468)

trodes, which must again absorb a certain number of electrons varying according to the deflection. As the beam is "ordered" so that a very insignificant number of electrons are caught by the deflectors when these are at zero potentials, an increase of the total number of electrons caught by the deflectors will practically always result when an R.F. current is applied.

The momentary number caught is a function of the rise and fall (fluctuation) of the R.F. voltage, and condenser C2 will be charged to a value depending on the momentary value of the controlling voltage; i.e., the voltage of condenser C2 will vary according to the modulations of the incoming R.F. voltage.

Besides the R.F. controlling voltages we thus get impressed on the deflectors a negative potential that numerically varies with the R.F. modulation, creating in the space between the deflectors a negative electric field that counteracts the positive field from the intensifier, and thus permits less electrons to get through to the plate.

OBTAINING DETECTION

The plate current therefore will vary with the R.F. modulation; i.e., an increase of the applied R.F. voltage will result in a decrease of the plate current (or detection).

Since in this arrangement the R.F. voltages on the deflectors at any time will be numerically equal but of opposite polarity, it is obvious that none of the R.F. oscillations in the input circuit will be carried over to the plate or intensifier (auxiliary plate) circuits. In plainer language: we get rid of those annoying tendencies to instability in the following A.F. stages, so familiar with conventional grid-controlled tubes.

The situation is different if we hook the Renode up in a circuit like that illustrated by Fig. 2B. In this case the R.F. voltages applied to the deflectors are both equal in value and polarity, which condition naturally sets up R.F. currents in the plate and intensifier circuits, varying in concert with the incoming signals.

In both diagrams the tube works as an "ordered beam"; however, in hookup A the beam moves brush-like, alternately towards either deflector plate, while in hookup B the beam "swells" in the middle, so to speak, and widens out towards the plates, as depicted in Fig. 1.

CHARACTERISTIC CURVES

With a view to further elucidating the behavior of the Renode a few characteristic curves drawn by the inventor on the basis of laboratory experiments are shown.

Figure 3A shows the detector characteristic of the Renode (A) as compared with an ordinary R.F. pentode (B). The grid leak in both cases was 2 megohms. (The readings on the vertical axis, left, are for the Renode, those to the right for the pentode; the units are in centimeters—i.e. readings on a large scale by means of a mirror-galvanometer—and they indicate relative values of deflector-currents plotted against input R.F. voltages at zero per cent modulation. To convert centimeters to inches, multiply the former by 0.3937.)

Figure 3B shows the total amplification of a Renode (A) as compared with that of an R.F. pentode (B). Input voltage (abscissa) in millivolts at 30 per cent modulation is plotted

against output in volts.

In Fig. 3C, is shown the selectivity curve for a Renode (A) and a pentode (B) working in identical tuning circuits. For the sake of clarity both curves are reduced to a peak of 1 V., but actually the Renode curve had its peak at 4.6 V., while the pentode reached only 3.75 V. The two dotted lines denote values of voltage obtained at a band width of 10 kc. For the pentode we find a voltage of 0.77-V. but the Renode yields 0.47-V. or 61 per cent less than that of the pentode. This spells: *better selectivity.*

THE PATENT SITUATION

A peculiar condition surrounds the development of the Renode, as explained below.

Initial experiments on the Renode were started some 5 years ago by A. Schleimann Jensen, a Danish engineer and radio editor. When, after 2 years, the fruits of his efforts were brought to the attention of the Radio Board of the Danish Post Office, which controls broadcasting in Denmark, the Radio Board secretly granted him a large sum to support further work. Some weeks ago he concluded his experiments and placed before an audience of experts (led by the chief engineer of broadcasting)—the Renode tube.

The Renode timed its appearance on the market at a psychological hour when the whole Scandinavian (Denmark, Norway, Sweden, and even Germany) radio industry is combining in a fight against the international tube and patent trusts.

In addition to the high prices for tubes (an American 50c tube sells in Denmark as a result of trust manipulations, for about \$5.00!), of which about 1/2 million are imported annually, the national receiver-production in Denmark has been liable to payment of considerable royalties to holders of certain vital patents. It is utterly impossible to build a modern tube set legally, unless sanctioned by the Dansk Radio Union (comprising 38 companies manufacturing radio equipment in Denmark), which, until now, has had complete control of set production. Now, however, with the advent of the Renode, four of the larger manufacturers have withdrawn from the Union, and are pinning their faith on the new tube!

The Norwegians are in much the same fix as the Danes, as far as tube prices and patent licenses are concerned. In addition, broadcasting is having a very tough time in Norway right now, since the mountainous country necessitates a large number of comparatively powerful broadcasting stations. But the building and expansion of such a network, to service only 175,000 listeners, who pay an aggregate license fee of about 3 1/2 million kroner annually, is very expensive. In an effort to acquire more revenue an attempt was made to increase the number of listeners by designing a very inexpensive radio set—a Norwegian edition of the German "Volksempfänger," or All-Peoples Receiver. However, real production has been withheld simply because the broadcasters are openly afraid that the international tube and patent firms will hamper the practical development by taking their toll on tubes and patent licenses.

We find in Sweden that the association of Swedish radio manufacturers is having a terrific battle with the tube firms, which are alleged to have attempted to exercise a regular dictatorship over the industry.

So, if the international trusts do not succeed in buying the Danish Renode people out—and I, for one, am perfectly satisfied they will not give in—it should be obvious that the Renode spells war on all other tube firms.

Fig. 3. Comparative characteristics of Renode and Pentode as a detector.

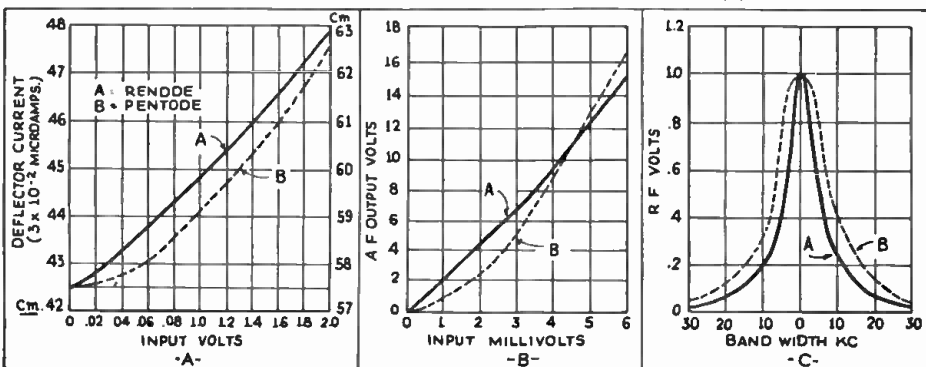

This versatile all-round high-fidelity combination tuner-amplifier unit was designed and built by LAFAYETTE Engineers in their laboratories exclusively for us. A single steel case contains a COMPLETE portable sound system, preamplifier, 3-channel mixer and high-fidelity radio tuner providing "studio quality" reproduction. It has a peak output of 35 watts; maximum output into plate impedance of 25 watts; maximum output into 500 ohm line, 20 watts. Harmonic content at rated maximum outputs is 5%. Gain, 110db; ill level—50 db. Model 159A. Price as illustrated but less (12) **\$79.50**

FREE CONSULTING SERVICE

Model 159A above is but one of many Lafayette amplifiers in the complete line. Lafayette engineers are known the world over for their accomplishments in the public-address field. They have assisted many radio dealers and servicemen to get into this profitable yet little worked branch of radio. For you, too, the opportunities are limitless, since Lafayette engineers will welcome YOUR questions and cooperate with you in solving YOUR individual sound problems. Consult with them—in person at any of our five salesrooms—or by writing our nearest mail order center. In the meantime get your FREE copy of our Catalog No. 59, which lists the world's largest and most modern selection of public-address equipment at LOWEST WHOLESALE PRICES.

WHOLESALE RADIO SERVICE CO., INC.
100 SIXTH AVE., DEPT. C-26.
NEW YORK, N.Y.

Send me catalog No. 59, listing P.A. Equipment.
 I have a P.A. Problem; see letter attached.

Name.....
Address.....
City..... State.....

WHOLESALE RADIO SERVICE CO.
NEW YORK, N.Y.
100 SIXTH AVE.
CHICAGO, ILL. ATLANTA, GA.
901 W. JACKSON BLVD. 430 W. PEACHTREE ST. N.W.
BRONX, N.Y. NEWARK, N.J.
542 E. FORDHAM RD. 219 CENTRAL AVE.

Please Say That You Saw It in RADIO-CRAFT

YOU'LL WANT this NEW MIKE
It stands at the cross roads
where price and
quality meet...

Now
only
\$45.00
List



Brush B2S
Microphone

Brush B2S Mikes are ideally suited for public address, remote pickup, sound car and dance band work. The best low price microphone for amateur transmission work. Typical Brush Sound Cell construction insures long life and satisfactory performance. Not affected by wind or severe changes in atmospheric conditions. Operates directly into high gain amplifier. No input transformer required. No distortion from close speaking. Fully guaranteed. Weight 3 ozs.—overall height 4 1/4 inches. Illustrated folder free on request. Send for yours. If your dealer cannot supply you with this big new value write

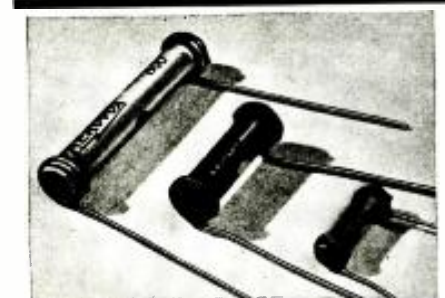

New and Better CARBON RESISTORS

They sure look good! And they're just as good as they look. Ideal for applications requiring non-inductive resistance dissipating 1 watt or less. • Solid molded carbon element. Non-fluctuating. Noiseless. • Accurate (within 10%) values stamped and R.M.A. color coded. • Non-inductive. Non-hygroscopic. • In 1/3, 1/2 and 1 watt ratings. All resistance values. And they cost no more!

DATA Your copy 1936 condenser and resistor catalog on request. Also sample copy of Research Worker. See your AEROVOX jobber for those better radio parts.



A \$30,000 "RADIO" INSTALLATION

(Continued from page 472)

average room, this room showed up the most minute sound. Speaker fields therefore were supplied from triple-filtered rectifiers, so that even though the entire job is a super-power, wide-frequency-range outfit, passing all the frequencies the human ear may grasp, operation is 100 per cent silent.

Each assembly of this super-deluxe radio-phono, installation is built to the highest standards. Chassis are of aluminum 1/4-in. thick, and all other metal work is either black lacquered or chromium plated.

The audio system has 4 stages of push-pull using the Hiler system of double-impedance coupling in all stages, providing a flat response from below 30 cycles to beyond the audio frequency band. The output uses two type 845 50-W. tubes. All filaments are heated by direct current. Low-voltage filaments are supplied by copper-oxide rectifiers, and higher-voltage filaments are heated from electronic rectifiers.

PATENTED PUSH-PULL DETECTOR

A most interesting feature of the system is the radio detection circuit. This consists of 2 triodes so connected that the plates each draw 1 ma. and operate 180 deg. out of phase with respect to each other. (Note that 1 tube is a "grid leak-condenser" type and the other a "plate detection" unit, in Fig. 2.) This is a push-pull detector circuit protected by patents. It results in exceptionally clean tone and is of course almost impossible to overload.

Old radio fans may recall the early Hiler audio circuits back in 1926 and 1927 which were not push-pull and which made use of condensers to create resonance at points where the relatively poor speakers of the day were weak in response. Improvements, however, have enhanced the efficiency. Coupling resonance has been designed to appear below the A.F. band; and because of the push-pull circuit, motor-boating is eliminated.

CIRCUIT ANALYSIS

The circuit of the amplifier, shown in Fig. 3, can be better understood by reference to the facts outlined below:

The two coils, L1, L2, each have an inductance of 3,000 hy. at no D.C. (all D.C. in the core is balanced out).

Coil L3 has an inductance of 3,000 hy. at 20 ma. D.C. but the primary wire is heavy, to carry the plate current of the third stage.

The secondary of T1 is used as the first choke of the amplifier and as input transformer when the phono. pickup is in circuit.

Resonance in the amplifier is about 3 1/2 cycles; thus no peaks are within the A.F. band.

No other system gives as much tube gain per stage, and, should any tube draw grid current, this will not harm the response.

The power stage will carry twice as much voltage input as other systems, thus with a class A rating we get 4 times the total power output when needed.

Grid and plate circuits may use separate chokes (such as the secondaries of high-class transformers), in all but the third-stage plate circuit.

Experience over a period of years has proven that a separate "B" power unit should be used for the output tubes. In this amplifier, therefore, a separate one is needed for the first 3 A.F. stages and one for the tuner. When 3 stages are used, only two plate supplies are necessary.

REMOTE-CONTROL CIRCUIT

The circuit of the remote control, Fig. 4, has the following characteristics:

In this circuit all dials in the house register at once, thus keeping a constant load on the circuit.

The output of the 874 regulator is up to 50 ma., constant between 90 and 95 V.

The 100-ohm resistors in the plus leads of the meters compensate for moisture, temperature, length of line and variations in all meters. In the finished job, each meter is calibrated separately and therefore all dials read alike and tune exactly to the station.

Unless such an individual rectifier system is used (that is, the rectifier doing nothing but supply current to the meters), the 874 regulator will flicker and at times go out, thus causing voltage surges, when the circuit is called upon to supply variable voltages and currents as in radio reception.

(The author will be glad to advise further in connection with sound installations of this type.)

REPLACEMENT TRANSFORMER LIST

The United Transformer Corp. has recently issued a bulletin listing over 1,500 sets made by more than 100 manufacturers. These many different sets may be serviced with a minimum of alteration by the use of only 10 different power transformers. Four types of mountings are available to cover all possible needs. Receivers up to the type using high power class B output systems are covered.

Write to *Radio-Craft* for your copy—ask for Bulletin No. 922.

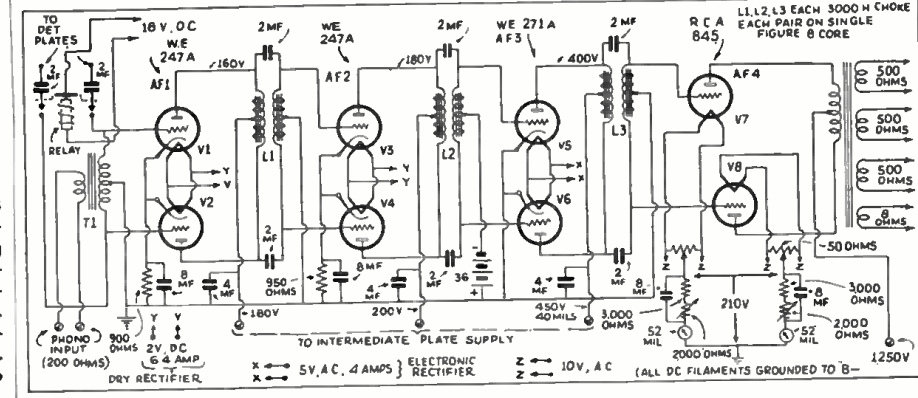
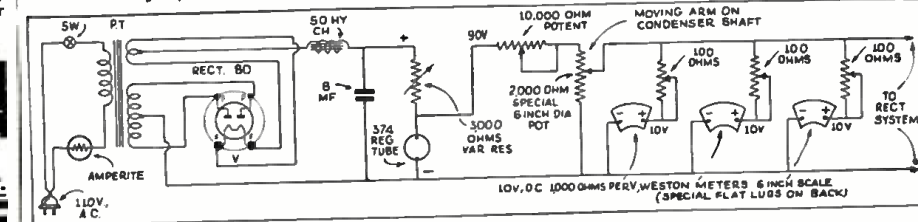

Fig. 3, above. The circuit of the amplifier which is push-pull impedance coupled throughout. Fig. 4, below. The universal tuning indicators with their special power supply.



Please Say That You Saw It in RADIO-CRAFT

SERVICING THEATRE SOUND SYSTEMS

(Continued from page 475)

around to the back and a cancellation of sound waves takes place, again causing decreased amplitude at certain frequencies, thereby making peaks in the sound response curve.

After horns or baffle boards are properly placed and mounted behind the screen, hair-felt or some other soft, sound-absorbing material should be used to cover the remainder of the space from the edge of the horn or baffle to the screen frame.

The original intention of the engineers who designed sound equipment was to present "wide range" or "high fidelity" to the theatre, since they designed the optical systems to function at from 50 to 9,000 cycles. However, the reproducing equipment until just recently would not permit such response, the average being around 100 or 125 cycles to 3,500 or 4,500 cycles. The number of high-fidelity installations is increasing rapidly and will present a few new problems to the Service Man. The RMA recently offered a tentative interpretation of "High Fidelity" as a range of frequencies of at least 50 to 7,500 cycles, with variations not to exceed 10 db.; and a total distortion factor not to exceed 5 per cent at an output of not less than 10 W. The factors controlling high fidelity are the ability of the sound head, amplifier, speakers and screen to pass a range of the above qualifications.

The tweeter horn has a small neck flaring out to a bell of some 4 or 5 ins. in dia., and requires no baffle. These horns are very directional and should be mounted above and as close to the large speakers as possible, with the tweeter horn projecting through the baffle board. Since these "tweeter" units are able to handle only about 1/3 the power that the larger speakers will handle with safety, blasting or overloading such units ruins the diaphragms, necessitating their replacement. The filter, however, besides providing the proper cutoff, also lowers the power input to the tweeter unit. When more than one reproducer is used, the voice coils should be paralleled. It is also necessary to "phase" the voice coils, that is, to have them all move in at the same time and out at the same time. Using a small "C" battery to get a click from the cones will give enough movement so that they can be checked by placing the finger tips near the web of the cone. The movements in and out should be simultaneous.

Refinished screens will present serious difficulty in passing the upper part of the audio band due to the decrease in the size of the perforations. Approximately 25 per cent of the total picture area should be perforated for sound. The cutoff (around 6,000 cycles) will be more noticeable with high-fidelity systems than with the older equipment.

Although auditorium acoustics may be out of the range of the Service Man's work, there are a few things he might do to improve sound reproduction conditions in some houses. Pieces of house equipment that are in resonance with certain frequencies of the audio band will not improve the sound. Peaks will be produced on the curve, as well as the rattling of the resonating object. Reflection and reverberation are the two most important items. Use of Sabine's formula (obtained from any good book on physics or acoustics) will help to calculate the amount of padding needed. It might be well to mention too, that a house can be over-draped, as well as underdraped. Sound absorbing constants for different types of seats, surfaces, drapes etc. usually accompany the formula. A note of 512 cycles is suggested for use with the formula in calculating the reverberation factor of auditoriums.

Noise filters can be used across arc lamp motors, projector motors and similar equipment causing interference in the sound. A good analyzer such as used in radio service work will take care of the general troubles, if the technician can measure voltage, current and resistance with it. However, if he wants to be able to meet all the problems efficiently, a good capacity and leakage tester, a good microammeter, a power-level meter, and frequency film will be of material aid. But regardless of how much test equipment he has, in order to get the desired results, he must, above all, be able to apply good common sense, know the fundamentals and have the ability to analyze a situation.



"HEAR THAT OXFORD!"

It may be a little 5" or 6" OXFORD Speaker in a midget set or it may be a larger 8", 11" or 14" super Auditorium model. Whatever the size or type, if it's an OXFORD unit it is delighting listeners with its rich, full toned, thrilling quality.

To get out of a radio or P.A. outfit all that's built into it, use OXFORD SPEAKERS. They give you TRUE reproduction. And there is an OXFORD Speaker for every radio and sound purpose.

REPLACEMENT SPEAKERS

Full line of REPLACEMENT speakers for all radio sets. Send for complete illustrated catalog No. 351-C or see your jobber for full particulars.



OXFORD-TARTAK RADIO CORP.
350 W. Huron St. Chicago, Illinois

Stop radio noises at their source

An interference suppressor that really works. Attaches directly to interfering device—not to radio. Simple to install. Sizes for every type of installation.



Write for complete details

THE AUTOMATIC ELECTRICAL DEVICES CO.

334 E. Third St., Cincinnati, Ohio



FILTRAD

A SIMPLE 2-TUBE A. C. SHORT-WAVE CONVERTER SELF POWERED

As Featured in January Radio-Craft (Designed by ROBERT G. HERZOG)

This latest creation of Thor's offers outstanding value and performance. Covers from 19 to 54 and 65 to 200 meters. With positive contact band selector switch.

Complete kit, as shown Unwired and less tubes, cabinet 49c 65c extra

Special: FREE DIAGRAMS sent upon request for any of the THOR Amplifier or Tuner Kits.

MAIL ORDERS PROMPTLY FILLED

THOR RADIO CORP.

167 GREENWICH ST. NEW YORK, N. Y.



Please Say That You Saw It in RADIO-CRAFT



... and Note the Difference!

Countless radio sets are working far below their peak efficiency—because poor condensers *won't let them do any better!* When filter condensers fail to supply the proper voltage—when cheap, inferior condensers are used—nothing about a radio can be wholly right. To test this assertion we only ask that you take a "sick" radio and equip it THROUGHOUT with Spragues. You'll be amazed at the improvement in "pep," volume and tonal quality.

Remember: You'll never go wrong with a Sprague.
Every condenser is guaranteed.

Sprague Products Co., North Adams, Mass.

SPRAGUE CONDENSERS

MADE RIGHT **SPRAGUE 600 LINE** PRICED RIGHT

We SPECIALIZE in the Design and Manufacture of Public Address Amplifiers
SEND FOR FREE CATALOG!
Number K-30
Describes in detail 86 different models and complete P.A. Systems ranging up to 200 audio watts output. 6 volt; AC; DC.
Buy Direct from Manufacturer AND SAVE BIG MONEY
Coast to Coast Radio Corp.
559-R Sixth Ave. New York, N. Y.

Radio Dealers & Servicemen!
S. O. S. CINEMAPHONE
16 and 35 m. m. Talking Picture Equipment
Lowest Prices!
Free Literature! may also be ideally used for Public Address
S. O. S. CORP. 1600 B'way., N. Y. C.

RADIOS.. SAVE UP TO 50%
DEAL DIRECT: Factory Price on Many makes to select from AC-DC. Allways, Farm, Car and new metal Tube Models. Your name and address on postcard brings you NEW 16 page 1936 Bargain Catalog in colors FREE. Get details of 30-DAY TRIAL plan and Agent-User proposition.
Goldentone Radio Co., Dept. 231
8780 Grand River, Detroit, Mich.

Get into RADIO REAL JOBS REAL PAY
Earn While Learning at Home!
TELEVISION, PHOTO ELECTRIC CELLS, PUBLIC ADDRESS
Many R-T-T trained Men make up to \$75 a week and more in full-time radio jobs \$5-\$15 in spare-time alone. More trained men needed. Learn at home by quick, easy, R-T-T WAY. Endorsed by 50 big concerns. Write for big opportunity Book FREE.
PHILCO CROSLBY ZENITH GRUNOW and 46 other mfgs. endorse R-T-T

THE LISTENING POST FOR ALL-WAVE DX-ERS

(Continued from page 473)

Japanese stations throughout the central, and eastern states so that the following list completely corrected up to date should be found of value. Watch these Japanese frequencies from about 4:00 am to daylight Eastern Standard time. (List, courtesy of Akifusa Saito, Japan.)

CALL	KC.	KW.	LOCATION
MTCY	560	100	Shikyo, Manchukuo
JFCK	580	1	Taihu, Taiwan
JOAK-2	590	10	Tokyo, Japan
JZJE	590	50	Tokyo, Japan (Experimental with irregular schedule)
JODK-2	610	10	Keljo, Chosen
JOTK	625	1/2	Matsue, Japan
JOIG	635	1/2	Kanama, Japan
JOJK	615	0.3	Akita, Japan
JQAK	650	1	Darien, Manchukuo
JO'G	655	0.3	Asahiga, Japan
JFAK	670	10	Talioku, Taiwan
JTFY	674	3	Harbin, Manchukuo
JONK	680	1/2	Hakodate, Japan
JOJK	680	1/2	Fukuoka, Japan
JOKK	700	1/2	Okayama, Japan
JOJK	710	3	Kanazawa, Japan
JIBK	720	1	Tainan, Taiwan
JOBK	720	1/2	Kochi, Japan
JOJK	735	1/2	Kokura, Japan
JOBK-1	750	10	Osaka, Japan
JOJK	770	10	Sendai, Japan
JOPK	780	1/2	Shizuoka, Japan
JOGK	790	10	Kumamoto, Japan
JOCK-1	810	10	Nagoya, Japan
JOJK	830	10	Sapporo, Japan
JOPK	850	10	Hiroshima, Japan
JOAK-1	870	10	Tokyo, Japan
JOTK	890	1	Hokkaido, Manchukuo
JODK-1	900	10	Keljo, Chosen
JOJK	920	1/2	Niikata, Japan
JOAG	930	1/2	Nagasaki, Japan
JONK	940	1/2	Nagano, Japan
JOJK	960	0.3	Kyoto, Japan
JORG	970	1/2	Maebashi, Japan
JOJK	980	1/2	Tokushima, Japan
JOFG	990	0.3	Fukui, Japan
JARK	1,030	0.15	Fuzan, Chosen
JORG	1,050	1/2	Kagoshima, Japan
JOIG	1,060	1/2	Toyama, Japan
JORK-2	1,085	10	Osaka, Japan
JOCK-2	1,175	10	Nagoya, Japan

THE LATEST FROM EUROPE

The new French Government station at La Brague, near Nice, is testing with 60 kw. of power on 1,249 kc., and will begin official operations shortly.

Radio Marseilles, at Marseilles, France, is also testing with 120 kw. of power on a frequency of 749 kc.

The new Toulouse-Muret PTT French station broadcasting with 100 kw. on 776 kc. was officially opened in October, 1935.

Radio Lyons PTT, Lyons, France, has been broadcasting with their increased power of 25 kw. on 1,393 kc. since October, 1935.

Work on the new anti-fading aerial for Leipzig, Germany, is completed and the station has been operating with its full power of 120 kw. on 785 kc. since October 3, 1935. The station's efficiency is said to be increased 70 per cent.

A new station at Reichenbach, Silesia will utilize 5 kw. on 1,231 kc. when it is completed. Linz, Austria, is to acquire the old 17 kw. transmitter of Vienna Rosenhuerel, to replace its present 500 W. station which broadcasts on 1,285 kc.

Salzburg, Austria is to get a new 5 kw. transmitter, and the power of Innsbruck, Austria is to be doubled.

LAST MINUTE REPORT ON

BROADCAST BAND DX

Just before we send this copy to press comes a report on broadcast-band foreign DX-ing from Randolph Tomlinson, Port Chester, N.Y., that should be of interest.

"DX here has been good, fair and 'rotten.' Have had some fine nights and mornings, only to have the next 'rotten' and hear nothing! Last night the band opened up on the Europeans, and I had Toulouse, Hamburg, Copenhagen, West Regional, Bari, Lille, Marseilles, Fecamp, Poste Parisien, Frankfurt, Hamburg, and others all over the dial but too weak to identify.

"The South Americans are very fine. LR5 has almost been equal in strength to WJZ. New York. LR3 is a nightly visitor here, as well as PRF4, on 923, LR4, LR6, LRS, LSS, LS2, CX26, all logged several times. HHK tears in here on Fridays on 921 kc. He is 1 kc. off frequency. WNEL, and WKAQ are excellent. CX34 was the best of the lot with only 500 W., but the worst difficulty is trying to get a report from these South Americans.

"Trans-Pacifics have been poor. 1YA being

about the only good one. 3GI, on 830 kc. seems to be on the air for good now, and should be fine in the Spring. I have never managed to snap a Jap yet, but am still hoping."

(So it would seem as we go to press that DX-ing conditions on the Broadcast Band are taking a turn for the better.—Editor)

NOTES FOR OUR SHORT WAVERS

WWV, owned by the United States Bureau of Standards puts on regular frequency transmissions as follows: Wednesday, Noon—1:00 pm, (15 mc.), 1:15-2:15 pm (10 mc.) 2:30-3:30 pm (5 mc.). These are extremely useful in calibrating a S.-W. receiver.

WOR, Newark, New Jersey, has again asked the F.C.C. for permission to start building the short-wave relay W2XHI, so, (despite the decision against building) the short-wave station may materialize after all.

W2XE, relay of the CBS at Wayne, New Jersey, is adding two new frequencies—17.76 mc., and 21.52 mc., respectively.

W8XKA, is the call of the new 5-meter station which relays W8XK's programs on an ultra-high frequency of 55.5 mc.

W1XAL, Boston, the educational broadcaster, has been granted permission to raise its power from 5 kw. to 10 kw.

Mexico is now the possessor of one of the finest short-wave stations on the North American Continent. The new station is XIBJQ, which is owned by the National Bank of Mexico, P.O. Box 2825, Mexico, D.F., and nightly relays XEW, on a frequency of exactly 11 mc. Although the power is only 1 kw. the signal reaches the U.S.A. with great power, and excellent modulation.

Another new station in Mexico is XEFT, "La Voz de Vera Cruz," El Primer Puerto De Mexico, Av. Independencia 28, Vera Cruz, Mexico. XEFT operates on 6.12 mc. and the schedule is 11:00 am to 4:00 pm, and 7:30 to midnight. On Sunday the schedule is 9:00 pm until early Monday morning, according to a verification received by Mr. John Shanks, of Russellville, Tennessee.

Perhaps the most important short-wave news of the month is the completion of the short-wave station "EL Mundo," of Buenos Aires, Argentina, which will relay LR1 on the broadcast band. This relay station puts on irregular tests preparatory to opening a regular service. The first was on October 13, at which time the relay operated on 9,890 kc., under the call LSN3. The second test took place on November 6th, from 5:00 to 7:00 pm, under the call LSL on a frequency of 10:25 mc. It is believed that this latter frequency will be used as a permanent channel, and that regular transmissions will shortly be started. By next month we hope to have complete information on "El Mundo," of Buenos Aires.

KKH, Kahuku, Hawaii (7.52 mc.) has been sending out a typical Hawaiian program for retransmission by CBS at 11:45 pm Monday nights. Before the program, KKH tests with KEJ (9.01 mc.) and KKQ of Bolinas, California.

Changes to Winter schedules, and frequencies have been made by the Japanese short-wave stations: The regular morning relay of JOAK, Tokyo is now being radiated by JVT (6.75 mc.) and occasionally JZG, 6.33 mc. The schedule is 4:00-7:40 am.

The regular Overseas Hour from 12:00 midnight to 1:00 am is now being radiated by JVN, Nazaki, on 10.66 mc. JVN is a considerable improvement over JVH on this schedule.

An additional overseas hour has now been added for reception on the Eastern coast of North and South America. This is radiated on Monday, and Thursday from 4:00 to 5:00 pm over JVM, Nazaki (10.74 mc.) and JVP, Nazaki (7.51 mc.). Reports on this transmission are especially desired, and should be addressed to the Kokusai-Denwa Kaisha Ltd., Osaka Bldg., Kojimachiku, Tokyo, Japan.

HJN, Bogota, Colombia is again transmitting (on 6.07 mc.) from about 6:00 to 9:30 pm according to Mr. John Shanks, of Russellville, Tennessee.

ORK, Ruyssedele, Belgium (10.33 mc.) is now broadcasting on its winter schedule of 2:30 to 4:00 pm. With its increased power it is being received much better in the U.S.A. at present.

On Tuesdays, and Thursdays at 10:00-10:30 pm PLV, Bandoeng, Java (9.415 mc.) may be heard relaying the native Javanese programs of YDE2, Solo, Java to an American audience. Occasionally PLE (18.82 mc.) or PMA, Bandoeng (19.35 mc.) also relay this program.

Please Say That You Saw It in RADIO-CRAFT

OSCILLOSCOPE SERVICING OF ALL-WAVE SETS

(Continued from page 474)

as to obtain a good sensitivity pattern on the oscilloscope screen, then turn the receiver off and allow it to cool.

After the set has cooled completely, turn it on again and watch the shape of the alignment curve change!

From this observation we may learn a valuable lesson: Before attempting to align an all-wave receiver it should be allowed to heat thoroughly.

The variations in all-wave receiver alignment sometimes caused by imperfect variable condenser contacts and bearings are readily seen with the oscilloscope.

CHECKING FOR PERFECT CONTACT

These variations may be observed by first aligning the R.F. and oscillator stages of the receiver in the usual manner; then detune the receiver by turning the variable condenser rotor a few degrees and return it to its original setting. If the condenser contacts and bearings are not making perfect contact, the oscilloscope screen will show that the receiver is again out of alignment.

On some receivers, it will be found that no matter how much care is taken in cleaning the condenser contacts, it still will be impossible to maintain a perfect alignment curve after the condenser rotor has been turned.

These sets require a slightly different method of alignment.

The correct procedure is similar to the method usually followed except that the variable condenser rotor is rocked slowly back and forth across the signal frequency while the trimmers are being turned (in much the same manner as in adjusting the oscillator padder on the ordinary broadcast receiver). If this procedure is carefully followed there will be little or no change in the alignment of the receiver after

the condenser rotor has been turned.

This method of balancing receivers is now being used by many of our largest set manufacturers and is a good one for any Service Man or set builder to follow.

IMPORTANT CONSIDERATIONS

The choice of oscillator and frequency modulator equipment is extremely important if it is to be used for all-wave alignment purposes. The oscillator should be stable and of sturdy construction. If the motor-driven type of frequency modulator is chosen, the motor preferably should be of the induction type. The electrical disturbances sometimes caused by brush-type motors, unless elaborate filtering is employed, make them unsuitable for short-wave alignment purposes.

Those types of synchronizing voltage generators which are operated by a commutator mounted on the wobbler-condenser shaft are generally to be avoided. The slight sparking which occurs as it charges and discharges its condenser can sometimes cause considerable electrical interference in the receiver under observation.

If physically possible, the oscillator and frequency modulator should be mounted together so as to form one complete unit, with the leads from the wobbler condenser to the oscillator made as rigid as possible. A slight change in the relationship of these leads can sometimes cause an appreciable shift in oscillator frequency on short waves.

It should be remembered that it is no easy or simple matter to align the modern multi-tube all-wave receiver. Time and care must be taken if we are to realize the true efficiency of the receiver.

There was a time, not so very long ago, when our set manufacturers considered an allotted time of 4 or 5 minutes extremely high for aligning a production receiver. With the advent of commercial all-wave and short-wave receivers it has become necessary to increase this allotted balancing time, in some instances, to as high as 30 minutes!

Fig. 2. A shows connection for a diode-detector output coupling to the vertical deflector; B shows connections from a resistance coupled detector; and C shows connections from a transformer-coupled detector.

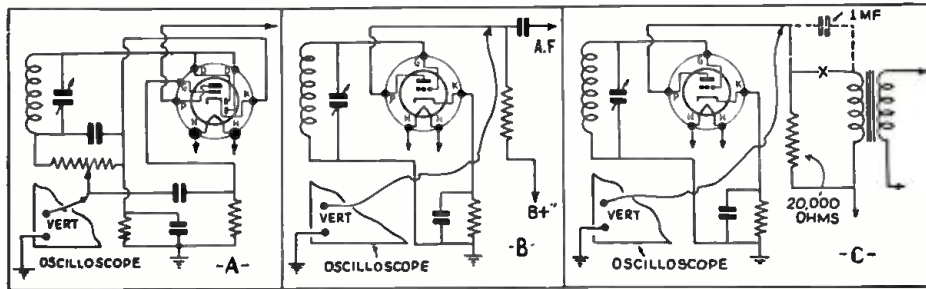

SHORT-CUTS IN RADIO

(Continued from page 476)

HONORABLE MENTION

CLOSED-CIRCUIT TIP JACK. This handy jack may be made from an ordinary tip-jack. All the needed instructions are given in Fig. 9. When the phone tip is inserted, the 2 lengthened prongs spread apart and open the circuit with the heavy wire that is to be added. An ideal jack for use in test sets and many other applications.

CHARLES HORVATH, JR.

HONORABLE MENTION

MOISTURE SEAL. In connection with some types of antenna installation in which soldered connections are desired, such as joints to be made on the roof, it is often very difficult to use a soldering iron or blow torch. In such cases it is often the practice to merely make a twist joint and tape it for protection. This is obviously very poor practice, and the writer has found that the use of common putty will provide a weatherproof covering under all conditions. Tape is used over the putty for protection. See Fig. 10.

LOUIS B. SKLAR

HONORABLE MENTION

INSTALLATION SUPPORT. A car radio is a heavy object, and the holder shown in Fig. 11 will be found a great help when installing or removing it from the car. The drawing is self explanatory, but mention may be made of the fact that the adjustable front seats found on most cars will be of help in adjusting the set holder.

E. T. GUNDERSON, JR.

HONORABLE MENTION

VOICE COIL REPAIR. After having repaired the voice coil lead on a particular speaker several times in a month, a turn was taken off to make a longer lead. The lead was wound into coil form, as shown in Fig. 12, and this seems to have cured the trouble, as the speaker has given over a year's service without trouble.

RICHARD T. SCHULTZ

HONORABLE MENTION

IMPROVING TONE. Many varieties of midget sets on the market do not have the tone quality that the owners desire. The combination shown in Fig. 13 has been used to advantage to improve the tone of several of these sets and may be of interest to readers.

F. U. DILLON

RAYTHEON

PARADE of All-Metal Radio Tubes



- 6A8—Oscillator-Detector
- 6K7—Detector Amplifier
- 6Q7—Diode Triode Amplifier Detector
- 6L7—Pentagrid Mixer Amplifier
- 6J7—Pentode Amplifier Detector
- 6F5—Triode Amplifier



- 6C5—Oscillator Amplifier
- OZ4—Full-Wave Gas-filled Rectifier (exclusively Raytheon)



- 6H6—Detector (Diode)



- 6F6—Power Amplifier
- 25A6—Power Amplifier
- 25Z6—Rectifier
- 5Z4—Full-Wave Rectifier
- 6X5—Full-Wave Rectifier (Auto Sets)

HEADQUARTERS FOR TUBE INFORMATION
Raytheon Production Corporation

30 East 42nd Street, New York, N. Y.
55 Chapel Street, Newton, Massachusetts
445 Lake Shore Drive, Chicago, Illinois
555 Howard Street, San Francisco, Calif.

FREE

VALUABLE NEW CATALOG
Filled With The Latest
RADIO PARTS
AMATEUR SUPPLIES
P.A. EQUIPMENT

SAVE at SEARS
Send for YOUR Copy TODAY

NEW DEVELOPMENTS!
NEW APPARATUS!
NEW LOW PRICES!

Every Radio Man Will Need New Equipment for Servicing The NEW METAL TUBES. You'll Find It in This New Catalog.

Famous Testing Equipment
SOLD ON EASY TERMS
The Latest Triplett—Readrite—Supreme—R.C.A. Clough Bringle and Triumph Instruments are All Included.

Write for Catalog 653 RC
SEARS, ROEBUCK and CO., Chicago

FREE RADIO Information

(1)—Write for FREE NEW CATALOG of Condensers, Transformers, Chokes, Sockets, Coils and technical data on receiving and transmitting equipment.

(2)—Attach 10c for New 32-page Manual of most popular Short-Wave Receivers, with Illustrations, diagrams and parts lists.

Address Dept. RC-2
HAMMARLUND MANUFACTURING CO.,
424-438 W. 33rd St., New York.

For Better Radio

Hammarlund

PRECISION PRODUCTS

COLUMBIA 18 WATTS CLASS "A" HIGH FIDELITY AMPLIFIER



With two-channel mixer for Ribbon &/or Crystal Microphones, Phonopickup, etc., complete with 6 tubes, \$40.00 Ribbon or crystal mike, Dynamic Speaker. (provision for additional speakers optional) neat and sturdy portable case, cables, etc. ready to operate. . . . \$54.55
Special Offer. . . Net

COLUMBIA SOUND CO., Inc., 135R Liberty St., New York City

30-18,000 CYCLES ± 1 D. B. MULTIPLE COIL Each Hum Free Construction Each Net:

Audio Transformers \$3.75

In Hum-Proof Cases

Midget A.F. Transformers and Chokes 1 3/8 x 1 1/2 x 2 3/8 inches \$4.00
Hum Proof Alloy Case, No. 1 and No. 2 0.75

ALLOY TRANSFORMER CO., Inc., 135R Liberty St., New York City

Correspondence Courses in RADIO and ELECTRICAL ENGINEERING

ELECTRICAL ENGINEERING covers complete electrical field. Most modern course. So simplified anyone can grasp quickly. **LOW COST!**

RADIO ENGINEERING Ultra-modern course in radio, public address, photo-electric work. Trains you to be super-service man, real vacuum tube technician. Diploma given. Tuition only \$25, either course. Deferred payment plan.

WRITE TODAY for free copies of school catalogs, student magazines, etc. **SEND NOW!**

LINCOLN ENGINEERING SCHOOL
859-D So. 37th St., Lincoln, Nebr.

MODERN STUDIO TECHNIQUE

(Continued from page 460)

the children's studio!

We mentioned before that the announcer's duties have changed a lot in recent years. In the early days of broadcasting, the announcer was the king-pin of the studio broadcast. He planned the programs so that they ended *some-where near* the correct time for station announcement; he assisted artists and sometimes acted as accompanist; he greeted guests and artists; he filled in when programs fell short; and in other words he was as indispensable as the microphone or transmitter.

Now, however, the announcer's duties are limited to station announcing, reading advertising "patter" and obtaining studio audience reactions to fit the program (applause at the right time, etc.). The timing of the programs and the planning of continuity (or "script") are taken care of by a person known as the *production manager*. He usually sits in the control room with the operator so that he has full control over the out-going program.

HAND SIGNALS

Since cooperation between announcer and production man are essential, and since verbal communication between them is obviously impractical, a set of hand signals has been worked up to handle this communication. Some of these signals are shown in Fig. D. The detail at A is the sign for "fadeout" at the end of the broadcast; B signifies that it is time for a local announcement; C tells the announcer to move the artist closer to the microphone; D tells the operator to cut the program after the music fadeout, and permits the relaxation that always follows a program for the artists, announcer, operator and production man; E signifies that the program must be cut—in case it is running too slow; and F tells the orchestra leader to end the musical selection, or, in the technical vernacular, close off.

There are other signals such as waving the hand in a circular motion to speed up the program. A finger planted firmly against the side of the nose signifies that the program is running according to schedule, etc.

Since these signals also apply directly to the artists, and are used by announcers to signal

to vocalists, musicians and speakers, as well as between the announcer and production man, some very amusing incidents have taken place from time to time. For example there was the case of the prominent man who was giving a talk. He noticed the announcer place his finger on his nose several times and misunderstanding the signal finally blew his nose violently and noisily to the consternation of the entire staff and the amusement of the listening public! Since artists are usually given a course in studio signals such cases are becoming rare, though.

THE STUDIO APPARATUS

The operations which the studio or control room operator handles can be understood from Fig. 2, which shows in block form the various parts of a studio amplifier. First there are the various microphones which may vary from one to a half-dozen or more for a studio broadcast. These are all fed into a mixing panel where the sound level of each can be individually controlled and mixed together to produce the signal sent out over the air. From this mixing panel, the signals are fed into a low-level amplifier which is also controlled from the same panel as the mixing potentiometers, by means of the master gain control. From this point, the signal is fed through a high-gain amplifier which feeds the signal directly to the power amplifiers in the transmitter or onto the balanced telephone lines to remote transmitters, in the case of network programs. A very small part of this output signal is tapped off and fed through an additional amplifier to operate the control-room speakers for monitoring the output. In this way, the operator and production man hear the program as it is actually transmitted.

The lower part of Fig. 2 shows the corresponding sound level in the various parts of the studio amplifier.

The relative positions of the control-room operator who "rides the gain" and the production man, as well as the control panel are shown in a striking manner in the illustration on the cover of this issue. Incidentally, this is a view of the auditorium studio on the 8th floor of the NBC studios at Radio City.

A rather interesting and unusual studio is shown in Fig. A at the head of this article. This studio, known as the Little Theatre, is designed especially for dramatic productions and has special lighting equipment and a glass curtain. Two control rooms are provided, one for

program monitoring and the other for controlling lighting effects, and the glass and opaque curtains. This studio is equipped with comfortable theatre seats for the audience and additional visitors can watch the programs from a glass enclosed balcony.

From this description of the make-up and operation of a modern studio the complexity of modern studio technique compared to the earlier varieties can be readily understood.

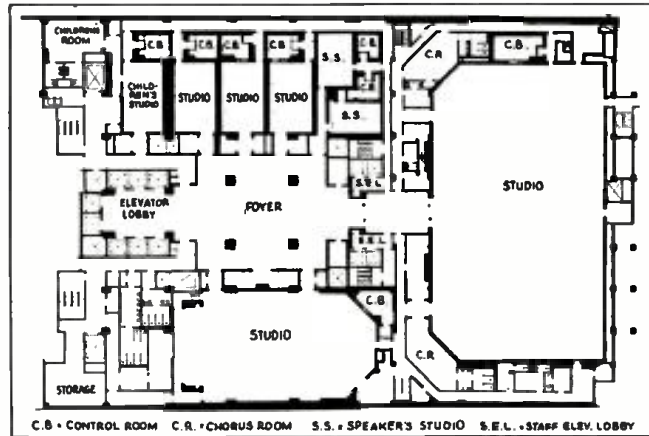

Fig. 1, above. The floor plan of the 8th floor of the Radio City Studios of N.B.C.

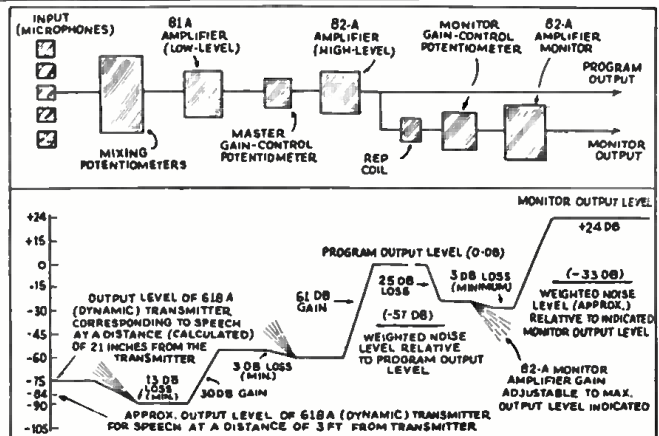

Fig. 2, right. Block diagram showing the action in the various parts of the studio amplifier equipment.

Please Say That You Saw It in RADIO-CRAFT

LATEST RADIO EQUIPMENT

(Continued from page 478)

and a loudspeaker (on detachable cover of carrying case). Control panel carries volume and tone controls, switches and level indicator.

PORTABLE RADIO RECEIVER (904)

FOUR TUBES, 2 of which are the double-purpose type are used in this compact portable super. Set has pilot light; and dynamic speaker. The cabinet, in suede-like finish, has a handle for carrying. Overall size, 5 $\frac{1}{2}$ x10 $\frac{1}{2}$ x7 $\frac{1}{2}$ ins. deep. Antenna is attached; no ground is needed.

6-W. AMPLIFIER KIT (905)

A 6-W. AMPLIFIER of high gain may be built from this kit. The amplifier is very flexible, since it may be used with any type of microphone or other input, and the output has taps for 500, 15, 8, or 4 ohms. Microphone current is supplied for carbon microphones, and 10 W. is available for field excitation of dynamic speakers. Power output 6 W.; maximum gain, over 106 db.

COUNTER TUBE TESTER (906)

(Supreme Instruments Corp.)

SIMPLICITY is a feature of this counter tube tester; an inexperienced person can readily operate it. The list of readings for various tubes is fastened to a small slide which pulls out from the bottom of the case. The large meter has (besides the English-reading "tube worth" scale) a scale for adjustment of line voltage. A large-size neon lamp is used for test purposes. All types of tubes may be accommodated.

HANDY RESISTOR KIT (907)

(International Resistance Co.)

THIS container with 8 drawers is furnished free with each purchase of a kit of 56 insulated resistors. The drawers are arranged in compartments with a larger one at the bottom to carry wire-wound resistors or other items. The resistors included are all of the 1 W. type and were selected to meet average service needs. The container is well finished and has handy scales and charts printed on the sides.

ALL-WAVE ANTENNA KIT (908)

THIS NEW kit comes to the user completely assembled and ready to install. All joints are soldered. The kit features the use of parallel feeders rather than the more usual twisted pair. The antenna is designed to be used with a doublet transformer, and in case the set has none,

an efficient unit is available. This kit is intended for use on the short-wave bands, but will be found to give a noticeable improvement on the broadcast band as well.

PORTABLE TIME SWITCH (909)

ANY HOME-electrical device may be turned on or off at any interval up to 12 hours by the use of this time switch. It may be used with radio sets, washing machines, lamps, or any such devices. The instrument is small and portable, so that it may be carried about conveniently to the point of use. A good seller for the Service Man to "plug."

PORTABLE UNIVERSAL AMPLIFIER (910)

THIS AMPLIFIER is truly "all-current" since it will work on 110 to 250 V. A.C., or D.C. lines and 6 or 12 V. batteries. Net weight complete is 40 lbs., and size is 11x13x17 ins. Input is arranged for carbon or crystal microphone, radio or phonograph. The equipment may be used indoors or out and has power enough to cover an audience of 2,000 people.

ALL-WAVE ANTENNA KIT (911)

THE BALANCED doublet system is used in this all-wave antenna kit. A highly efficient matching transformer is employed. All components are of the highest quality. A special grade of twisted wire is used for the feeders to insure the best possible results. All required insulators and wire are furnished.

NOISE REDUCTION FILTERS (912)

(Continental Carbon Co., Inc.)

THE FILTERS pictured here are designed for a variety of machines which produce "man-made" static. Two are of the plug-in type which are connected between the apparatus cord and the power socket. The other two are for permanent installation on such equipment as oil burners, neon-light transformers and the like. Some of the types use a combination of inductance and capacity, while others contain capacity alone.

TWO NEW BOOKS (918-919)

TWO interesting books of interest to the Service Man and technician have just been printed by two prominent companies.

The first is called Tube Talks—it presents some very interesting facts about tubes in general and includes a section on the tube complements of a large number of manufactured receivers. The latter feature alone makes it well worth the price.

(Continued on page 507)



This 1300-page book has EVERYTHING

Chirardi's new MODERN RADIO SERVICING, reviewed in this issue of RADIO-CRAFT, contains every particle of information you'll need for bringing your servicing methods right up to the minute. It's based on the experience of many of the most successful servicing organizations in the U. S. Here's what it contains:

TEST INSTRUMENTS

Full details on all latest commercial models and construction data for homemade units—diagrams, constants, etc.. Included, Comprehensive, 393 pp.



SERVICING METHODS

Most up-to-date successful methods fully explained—general procedure, receiver analysis, alignment by Cathode-Ray method, etc. 275 pp.

REPAIRING PARTS

This section tells you exactly how to repair every receiver part—when it is advisable to do so. Practical, 101 pp.



SPECIAL PROBLEMS

Auto radio installation and servicing; all-wave receiver problems; marine radio; elimination of interference and noise; high-fidelity receivers; etc. 296 pp.

SELLING SERVICE

Live-wire tips on selling, advertising and merchandising. Business forms and records. Scores of tested money-making ideas. 40 pages.



FIELD DATA

Separately-bound supplement. I-f's for 3,400 superhets. Trouble-shooting table for 750 receivers, ignition data, including new 1936 cars, grid bias resistor chart, etc. 240 pp.

You need this book—it will make money for you. Mail the coupon today!

MODERN RADIO SERVICING

with 240-page FIELD DATA Supplement
\$5.00

RADIO & TECHNICAL PUBLISHING CO.
45 Astor Place, New York
Dept. RC-2

- Please send your Introductory Combination Offer of both books at \$5.
- Please send FREE literature describing contents of books in detail.

NAME _____
ADDRESS _____

OCCUPATION

- What kind of information do you need most? Test Instruments? Newest test methods? Sales and advertising? Case histories? Repair methods?

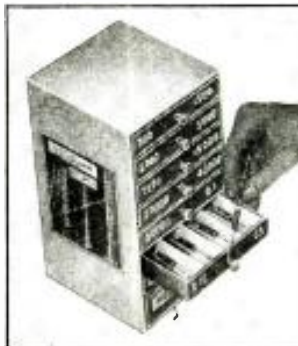

A handy resistance kit for Service Man or Dealer. (907)

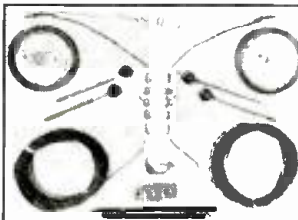

Antenna kit. (908)
Noise filters. (912)



Time switch. (909)
All-wave antenna. (911)

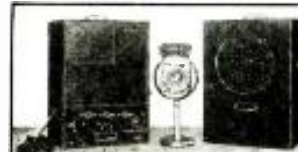
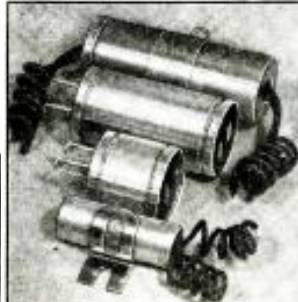

Portable amplifier. (910)

Please Say That You Saw It in RADIO-CRAFT



The OUTSTANDING ALL-WAVE SIGNAL GENERATOR

THE highest requirements of precision and convenience for all-around work are met in the Model 339 Signal Generator, that works on a.c. or d.c. of 90-125 volts, to measure frequencies from 54 to 17,000 kc. and line up channels. It also serves for determining the frequency of a station that is being received.

Coincidence of generated frequency and scale reading is 1 per cent. This high order of accuracy obtains in no other instrument selling at less than twice the cost of the 339.

Many, no doubt, have been somewhat confused by the numerous types of signal generators, but will note that the best of them cover wide ranges on fundamentals, have an attenuator, and permit of pressure or absence of modulation. Also they have a vernier dial and are direct-reading in frequencies, accurate to at least 3 per cent. The 339 has all these advantages, besides affording wavelength determinations as well, and operation on 90-125 volts a.c. (any commercial frequency) or d.c. And the accuracy is three times as great. Moreover, the 339 is well built, for lifetime use, and covers all waves fundamentally, besides permitting measurements of frequencies up to 100 mc (down to 3 meters) by resort to a slight calculation method, applying a simplified harmonic system to the 5,400 to 17,000 kc. fundamental band.

The 339 has a 6D6 17. oscillator, a 37 rectifier tube, so that d.c. is used on the plate, while modulation is provided by a neon tube relaxation oscillator at a frequency of about 1,000 cycles.

- 54 to 17,000 kc., all on fundamentals, switch operated, direct reading in frequency and wavelength; universal operation. Modulation on-off switch and attenuation. Electron coupled. Wired, tested, calibrated, with three tubes (6D6, 37 and neon).
- Shipping weight, \$16.00
- 8 lbs.



RADIO CONSTRUCTORS LABORATORIES
136 LIBERTY STREET Dept. RC NEW YORK, N. Y.
All Shipments in 24 Hours After Receipt of Order.

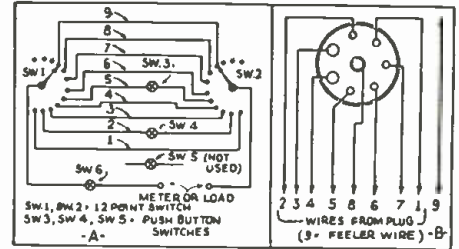

The circuit of the selective analyzer and the analyzer cable and plug. (917)

BANDSPREAD RECEIVER KIT (915)

(Continued from page 479)

broadcast bands or the amateur bands may be spread over 60 to 90 per cent of the bandspread scale.

Due to the use of two high-gain A.F. stages, the volume on almost any station within the range of the set may be brought up to the very highest level. The pentode output tube provides sufficient power to overload the speaker.

The panel carries controls for volume, regeneration, R.F. stage trimmer, and power switch.

SELECTIVE ANALYZER AND TUBE TESTER (917)

(Continued from page 479)

The metal case is only 7x7x3 ins. high, making it handy for the Service Man to carry in his tool kit.

The Selective Analyzer

The selective analyzer unit is a companion, low-priced, but very efficient, instrument. Used in conjunction with a suitable meter, it enables the user to take readings from any two contacts of the socket under test, or directly to ground. A safety button is incorporated to protect the meter while making adjustments.

Several contacts of the selector switches are unwired to provide for future tubes.

The analyzer is supplied complete with cord, plug, adapters, and instructions, but without meter. The case measures 7x4x3 ins. deep.



IT'S DIFFERENT IT'S BETTER...

R 21H

Radio to Set Ant. Line

... A Short and Long Wave Lamp Socket Aerial!

Ask your serviceman for free demonstration. Send for Bulletin 103 with complete information.



13914 Lorain Ave., Cleveland, Ohio Toronto, Ontario Canadian Factory

MAKE YOUR OWN RECORDS

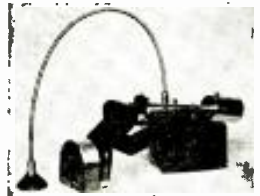

From Radio or VOICE We specialize in complete recording devices for professional and amateur work. We manufacture all types of home and professional recording apparatus and cutting devices for any metallic or non-metallic disc material. Write for details on your needs.

SOUND APPARATUS COMPANY
Manufacturers of Disc Recording Apparatus
150 West 46th St. New York, N. Y.

AMPLIFIERS AND SOUND SYSTEMS

High Power low cost Amplifiers and Systems for every purpose, from 3 1/2 Watts to 100 Watts, incorporating every advanced engineering feature and modern design. Sound systems for halls, restaurants, theatres, schools, churches, stadiums, autos and all types of outdoor and indoor installations. Also, a complete line of Microphones, Dynamic Speakers, Portable Sound Systems, Exponential Horns, Electric Phono, Pick Ups, Phono, Motors, Recording Equipment, Tubes, etc. Write for complete catalogue. INTER-WORLD TRADE CORP. 315 FIFTH AVE. New York City



RADIO ENGINEERING,

broadcasting, aviation and police radio, servicing, marine radio telegraphy and telephony, Morse telegraphy and railway accounting taught thoroughly. Engineering course of nine months' duration equivalent to three years of college radio work. All expenses low. Catalog free. School established 1874. Dodge's Institute, Hudson St., Valparaiso, Ind.

STOP GUESSING!

Radio service is easy when you know just where to look for the trouble. A CHICKER trouble-graph and repair-pricer eliminates guess-work in what is wrong and what to charge. Used by progressive servicemen everywhere. Price 50c post-paid. (No Stamps.)

PAUL G. FREED
Publishing Division R
5053 Baltimore Ave., Philadelphia, Pa.

ENTERTAINMENT SYSTEM (913)

(Continued from page 479)

the line, 175 W.; frequency response, 50 to 15,000 cycles, with 2 db.; 13 tubes used.

The four 2A5 output tubes are connected in push-pull parallel, and are used as triodes, the screen-grids being hooked to the plate for this use. The harmonic content is less than 5 per cent at maximum volume. The operation is class A at normal levels and class A prime at maximum volume.

FARM RECEIVER (914)

(Continued from page 479)

unit may be tilted by a pull cord when operation is not desired.

As with the usual windmill, the fin blade of this charger keeps it facing into the wind.

Equipment furnished includes a 5 ft. tower of metal, ammeter, cutout, and battery clips.

The combination of the wind charger and the low-drain superhet. are said to give results equal to a fine power line set at a greatly reduced operating cost.

This circuit shows how the tubes are used in the 13-tube high-fidelity T. R. F. set and P. A. amplifier. The tube action can be understood from the block detail. (913)

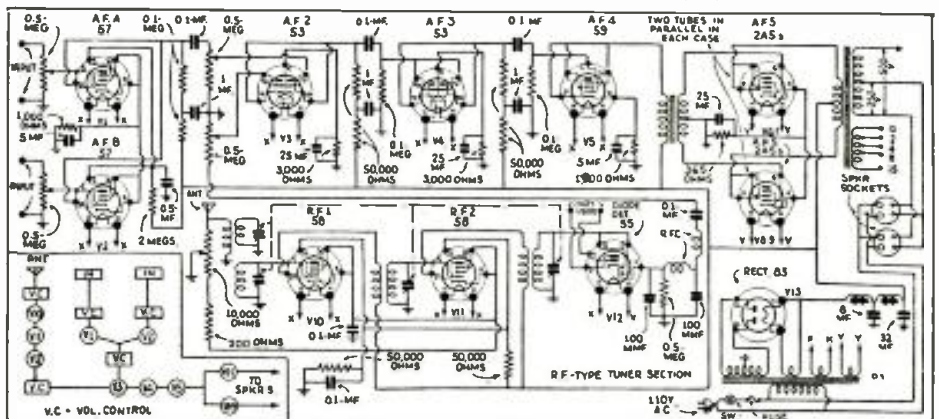

The circuit of the low-current battery set which operates from a battery charged from a wind-driven generator—note the vibrator type of high-voltage supply used. (914)

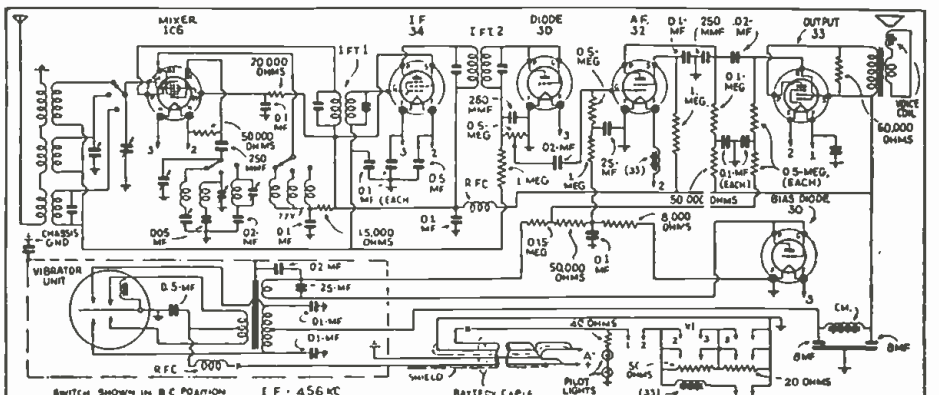

Please Say That You Saw It in RADIO-CRAFT

Here are two NEW 10c BOOKS



Each book contains 32 pages—and is well illustrated.

LITERALLY thousands of radio fans have built the famous DOERLE Short Wave Radio Receivers. So insistent has been the demand for these receivers, as well as construction details, that this book has been specially published.

HOW TO MAKE FOUR DOERLE SHORT WAVE SETS

Contains EVERYTHING that has ever been printed on these famous receivers. These are the famous sets that appeared in the following issues of SHORT WAVE CRAFT: "A 2-Tube Receiver that Reaches the 12,500 Mile Mark," by Walter C. Doerle (Dec., 1931-Jan., 1932); "A 3-Tube 'Signal-Gripper,'" by Walter C. Doerle (November, 1932); "Doerle 2-Tube, Adapted to A. C. Operation" (July, 1933); "The Doerle 3-Tube 'Signal-Gripper' Electrified," (August, 1933) and "The Doerle Goes 'Band-Spread'" (May, 1934).

HOW TO MAKE THE MOST POPULAR ALL-WAVE 1- and 2-TUBE RECEIVERS

THIS book contains a number of excellent sets, some of which have appeared in past issues of RADIO-CRAFT. These sets are not toys but have been carefully engineered.

- The Measdyne 1-Tube Pentode Loudspeaker Set, by Hugo Gernsback.
- Electrifying The Measdyne.
- How To Make a 1-Tube Loud-speaker Set by W. P. Cheney.
- How To Make a Simple 1-Tube All-Wave Electric Set, by W. Green.
- How To Build A Four-In-Two All-Wave Electric Set, by J. T. Bernady, and others.

And believe it or not, each book contains 32 pages and over 15,000 words of new leside type. Each book is thoroughly modern and up-to-date. They are well illustrated. They are not just a reprint of what was printed before. All the latest improvements have been incorporated into the sets.

Remember, these books sell at the extraordinary low price of ten cents each. You can not possibly go wrong in buying them. Despite its low cost, our usual guarantee goes with these books as well—money refunded if not satisfied.

There has never been such a wealth of data published in a low-priced radio book of this type in the history of the radio publishing business.



RADIO PUBLICATIONS
99 (RC) Hudson Street
New York, N. Y.

AIR CONDITIONING is America's Next Great Industry

THE idea of electricians, radio service men and other mechanically inclined men servicing Air Conditioning and Refrigeration Units is self-evident and the thought has occurred to some untold thousands ever since air conditioning equipment has been installed in public auditoriums, theatres, studios, department stores, office buildings and manufacturing plants. The tremendously broad possibilities in this new industry are bound to give employment and success to men far-sighted enough to see its advancement and development.

Well-known Engineer Edits Manual

THE OFFICIAL AIR CONDITIONING SERVICE MANUAL is edited by L. K. Wright, an expert and a leading authority on air conditioning and refrigeration. In this Air Conditioning Service Manual nearly every page is illustrated; every modern installation and individual part carefully explained; diagrams furnished of all known equipment; special care given to the servicing and installation end. The tools needed are illustrated and explained; there are plenty of charts and page after page of service data.

CONTENTS IN BRIEF

History of Air Conditioning; Fundamental Laws; Methods of Refrigeration; Elector System of Refrigeration; Compression System of Refrigeration; Refrigerants; Lubricating Oils; Liquid Throttle Devices; Servicing Expansion and Float Valves; Servicing Refrigerating Systems; Control Devices; Thermodynamics of Air Conditioning; Weather in the United States; The Field of Air Conditioning; Insulating Materials; Heat Transmission Through Walls; Complete Air Conditioning Systems; Estimating Requirements for the Home, Small Store, Restaurant; Layout of Duct Systems; Starting Up a System; Operating and Servicing Air Conditioning Systems; Air Filtration, Ventilating and Noise Eliminating Devices; Portable Electric Humidifiers and Room Coolers; Automatic Humidifiers; Air Conditioning Units for Radiator Systems and Warm Air Systems; Central Conditioning Units, etc.

352 Pages
600 Illustrations
9x12 Inches

Flexible, Loose-Leaf
Leatherette Cover

\$5.00 A COPY



(Send remittance by check, money order or unused U.S. Stamps. Register letter if it contains stamps or currency.)

GERNSBACK PUBLICATIONS, INC.
99R Hudson Street New York, N. Y.

ORSMMA MEMBERS' FORUM

(Continued from page 480)

car radio sets, this seems to be generally recognized as a very unreliable piece of apparatus and the trouble will generally be found to be due to poor adjustment of the contacts or a poor grade of tungsten, or both.

Having been fortunate enough to have worked in many telephone offices for several years, where harmonic ringing converters were in use, I realize that the average Service Man who has not been so fortunate is decidedly up against it. As a general rule 4 frequencies were in use in these harmonic converters, consisting of 16 cycles (1,000), 33 cycles (2,000), 50 cycles (3,000) and 66 cycles (4,000) per second and one can readily see that if these frequencies were not up to standard at all times, interference caused either by poor adjustment or pitted contacts was very likely to arise.

When trouble is experienced with vibrator units, the equipment should be dismantled—and if the contacts are simply blackened but not pitted, they should be cleaned with commercial carbon tetrachloride and burnished with a very light steel spring, such as an old clock spring. If, however, inspection reveals that the contacts are pitted they may be smoothed down with *crocus cloth*, NOT emery paper (which should not be used under any consideration). The contacts should then be given a final polish by rubbing down on an oilstone. Reassemble the unit and with a gauge check the air gap between the blade and contacts, which will generally be found to be about .008- or .004-in. on each side. The air-gap adjustment naturally will depend upon the speed of the armature—the higher the frequency, the closer the contacts to prevent any possible chance of sparking (which accounts for more than 90 per cent of the trouble).

For very accurate adjustment, I use a 30 V. Weston 10,000 ohm meter with a 200-ohm shunt, which permits very accurate adjustments. After starting the vibrator, the meter and battery are put across the contacts, first on one pair of contacts and then on the other. Then the contacts are adjusted until a reading of 8.5 to 9.5 V. is recorded on the meter on each contact.

FRANK H. HAYDEN,
West Side Radio Service,
Alpena, Mich.

A SCHOOL-TYPE BROADCAST STUDIO

(Continued from page 481)

able experience of servicing all of the equipment.

The main studio is of the "live end—dead end" type while the smaller studios are of conventional design. Rock wool, acoustic plaster, and monk's cloth are used for acoustic treatment. The microphones which are used are all of the condenser type; and complete sound-effects materials are included as a part of the studio equipment.

A partial view of control room F is shown in Fig. A and here will be seen students working at the mixer desk and the input control panels. This control room, in addition to the mixer, contains a low-level amplifier, a high-level amplifier, distribution panel, and battery charging equipment.

The output of the low-level amplifier is so arranged that it may be connected through a 500-ohm transmission line to the input of the A.F. amplifying equipment (which is located in the transmitter room on the floor above).

The transmitter includes a dual audio channel and mixer panel, a 50-W., crystal-controlled exciter, feeding a modulated R.F. amplifier and 200-W. class B linear R.F. amplifier. A modulation percentage indicator of the cathode-ray tube type and an audio oscillator also form a part of this equipment (which is used for testing, as well as for instructional purposes). A complete power installation, and stand-by motor-generator sets are also included in the transmitter room.

To enable unlicensed students to operate this station equipment, a dummy antenna system is used at such times when programs are not being released over the air.

This article has been prepared from data supplied by courtesy of National Schools.

Whether You

Service
RADIO RECEIVERS

Sell
RADIO EQUIPMENT

Operate
A "HAM" STATION

Build
YOUR OWN RADIO

or
Install
PUBLIC ADDRESS

YOU NEED

The 1936 ALLIED Radio Catalog! A different book—a live book—a money-saving, time-saving book—the answer to all of your needs. More than 10,000 sparkling items covering every radio field: every modern test instrument, thousands of replacement parts, tools; dozens of new All-Wave and Metal Tube Receivers; complete Amateur gear lines; famous Build-Your-Own kits; a brilliant P.A. presentation—the catalog with everything for everyone in Radio. Send the coupon now!



ALLIED RADIO

ALLIED RADIO CORPORATION,
833 W. Jackson Blvd., Dept. D.
Chicago, Illinois.

Send me at once your FREE 1936 Catalog—the Leading Radio Supply Guide.

Name

Address

City State.....

7-TUBE SUPER KIT

Kit Includes: ANTENNA COIL; R.F. COIL; OSCILLATOR COIL; 1st I.F. COIL; 2nd I.F. COIL; 3-GANG TUNING CONDENSER. Price ... **\$1.95**
Schematic circuit diagram for A. C. and Auto Receiver furnished.



T.R.F. KIT

ANTENNA COIL; 2 R.F. COIL; 3-GANG TUNING CONDENSER. Price **\$1.25**
Write for our special circular radio parts and tubes.
Send enough money for parcel post or we ship by express collect.

ARROW SALES CORPORATION
631 Washington Blvd., Chicago, Illinois

NEW LOW PRICE on AMPERITE CURRENT AND VOLTAGE REGULATORS



Amperite replacements for AC-DC sets now LIST \$1.25. Amperite 3-40 can replace AC-DC set regulators 50x3, 300, and 5B. Also new low price on replacements for 2-Volt Battery Sets, List \$1.40

Write for CHART CV.
AMPERITE Co. 561 BROADWAY NEW YORK

NEON

Prepare yourself quickly for today's biggest opportunity—NEON or "gaseous tube" lighting—most widely used medium of lighted displays, the future's greatest source of illumination. Splendid future. Trained men needed in every locality. Start now while the industry is still new!

FREE Booklet describes NEON'S opportunities and complete data on the practical C. L. home-study course. Low enrollment fee will amaze you. **WRITE TODAY!**

COMMERCIALITE LABORATORIES, Box 47-R, Omaha, Nebr.

Actual Troubles in Radios

By **BERTRAM M. FREED**

Consists of 200 Pages (46 diagrams) of proven solutions to service breakdowns which have stood the test of time. Tells how to locate and make repairs on over five hundred different model receivers. One free supplement. For sale by leading mail-order houses and radio parts jobbers, or direct from us. Price \$1.00.

SERVICEMEN'S PUB. CO.
172 Washington St. New York City

SERVICEMEN

Complete line Replacement Parts, Short Wave and All-Wave Receivers, Amplifiers, Test Equipment and Accessories. All at Rock Bottom Prices.

CONSOLIDATED RADIO PRODUCTS CO.
Box 23 Northwestern Sta Detroit, Mich. Dept 22K

FREE
NEW 1936 RADIO BARGAIN CATALOGUE

RADIO ENGINEERING

RCA Institutes offers an intensive course of high standard embracing all phases of Radio, Practical training with modern equipment at New York and Chicago schools. Also specialized courses and Home Study Courses under "No obligation" plan. Catalog. Dept. RT-36

RCA INSTITUTES, Inc.
75 Varick St., New York. 1154 Merchandise Mart, Chicago
Recognized Standard in Radio Instruction Since 1909

Reduce Noise On ALL Waves

LYNCH HI-FI ASSEMBLED ALL-WAVE ANTENNA
All ready to hang. Saves 90% of installation time. Amazing results. **\$6.75** List

Write for folder

LYNCH FILTERADIO
Cuts out objectionable noise from the light line. Easy to install. Sample to adjust. **\$5.00** List

Arthur H. Lynch, Inc., 227 Fulton St., N. Y. PIONEER OF NOISE-REDUCING AERIALS

A BROADCAST P.A. UNIT FOR MUSICIANS

(Continued from page 481)

people regarding the reproduction of music, find difficulty in getting a system to satisfy them. To meet the demand for an outfit that will fill all requirements, a sound system containing many novel features has been developed. It is simple to operate, versatile, excellent in quality, powerful enough for ordinary purposes, neat in appearance and portable. It attempts the rather difficult feat of satisfying both the layman unfamiliar with electricity (particularly the musician), and the sound engineer.

The heart of this sound system is the amplifying unit, consisting of the amplifier proper, a high-fidelity A.C. or A.C.-D.C. outfit delivering 18 W., and a powerful 10 in. speaker. Provision is made for the use of additional loudspeakers. This amplifier is mounted in a handsome black leatherette-covered case with chromium plated trimmings, and tube and speaker grilles. The case measures 15 x 15 x 8 ins. deep, and yet there is also room for a microphone with cable and a folding microphone stand, thus placing within one neat carrying case a sound system complete in itself, the entire weight being only 29 lbs.

NOVEL APPLICATION

There are really four essential ways of amplifying the sound output of the guitar, for instance. One is the conventional fashion of placing a microphone near the guitar, which is quite unsatisfactory because it picks up other instruments to the same extent. Some guitar manufacturers replace the instrument strings by metal strings and maintain inductive pickup or pickups near the bridge. The sound thus obtained is quite artificial and differs greatly from the natural sound.

A much better method is the use of a "crystal cartridge" such as used in crystal pickups. The best method, however, is the use of an especially designed crystal cell unit which is simply taped down onto the instrument. Not only can this unit be removed and attached in a jiffy, and at will, but it will give most amazing, realistic, faithful amplification of the weakest tones.

One more interesting way of obtaining the same results is by using a so-called "bridge." Such a bridge can be used both as a normal bridge (which is the part supporting the strings), and as a means of translating the vibrations of an instrument into electrical oscillations so that the tone of the instrument can be reproduced and amplified faithfully.

The 2-channel input mixer in the amplifier provides many useful applications of it for the musician. Two string instruments, such as a Hawaiian guitar and a Spanish guitar, 2 violins, or 2 of any kind can play duets together. For most purposes a string instrument player can play together with a phonograph or radio set. These things can, of course, be done by any instrument by using ordinary microphones in place of the bridge pickups. With an orchestra 1 microphone can be used for a vocalist and the other for the orchestra, each independently controlled, or 2 microphones can be used to obtain better balance for an orchestra when amplifying it. Many other uses can be found for this mixer.

This article has been prepared from data supplied by courtesy of Columbia Sound Co., Inc.

The metal-tube amplifier and the case.

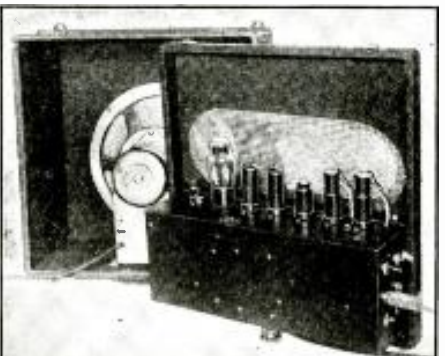

Over 130,000 People Find Each Issue of

EVERYDAY SCIENCE AND MECHANICS of Intense Interest!

EVERYDAY SCIENCE AND MECHANICS is the finest scientific-technical-mechanical constructional magazine in the field. Up-to-the-minute with news flashes of scientific events. Dozens of constructional articles and many popular experiments. Ideas from which you can make things to sell.

A Host of Interesting Subjects Covered:
Woodworking—Photography—Magic—Patents and Inventions—Book Reviews—Metalworking—Chemistry—Engineering—Microscopy—Electrical Experiments—Household Helps—Astronomy—Prize Contests—and other subjects.



10c
THE COPY

ON ALL NEWSSTANDS OVER 150 ILLUSTRATIONS

- - a new magazine for short-wave fans!

SHORT WAVE LISTENER

4,600 Short Wave stations listed



THE finest magazine of its kind ever published—totally different in get-up and contents from any other. Contains the largest listing of short wave stations in the world, up-to-the-minute, including "Police," "Television" and short-wave stations, as well as a special list of the star short-wave stations with their frequencies and call letters. Also contains photos and descriptions of short-wave broadcasting stations in various parts of the world with photos of short wave studio artists and other hints for the "short-wave listener"—Question and Answer Department for the "Listener"—Silver Cup Trophy for best photo of listening "Posts."

NOW 15c
the Copy

ON ALL NEWSSTANDS 99 Hudson St. New York, N. Y.

Every SHORT-WAVE SET-BUILDER NEEDS THIS BOOK

Every experimenter who has ever tried to build a short wave set knows by experience, the difference between a good and a poor receiver is usually found in the short wave coils. Often you have to hunt through magazines, books, etc., to find the information you require. The present book has been gotten up to obviate these difficulties.

In this book you find every possible bit of information on coil winding. Only the most modern "dope" has been published. Illustrations show, giving not only full instructions on how to wind coils, but dimensions, sizes of wire, curves, how to plot them, by means of which any coil for any particular short wave set can be figured in advance, as to number of turns, size of wire, spacing, etc. There has never been such data published in such easy accessible form as this.

Sent to you up on receipt of **25c** in cash or unused U.S. Postage Stamps

RADIO PUBLICATIONS, 101C Hudson St., New York, N. Y.

Please Say That You Saw It in RADIO-CRAFT

OUTSTANDING MERITS OF METAL TUBES

(Continued from page 470)

means something more than compactness of sets. It means also that the tubes can perform more efficiently. The short leads of an all-metal tube are shown in Fig. D. The low inductance of these short leads permits high tube sensitivity, especially at the short wavelengths. Also, the bracing effect of these stiff stubby wires helps to make the electrode assembly rigid.

Another outstanding feature of the all-metal tubes is the excellent shielding provided by the metal shell. It is not only true that the all-metal tubes are self-shielded and require no extra shielding apparatus; it is also true that the shielding provided by the metal shell is almost perfect. There are more functions performed by this shielding than are generally realized.

FUNCTIONS OF A TUBE SHIELD

Of course, most radio men know that the main function of tube shielding is to cut down feed-back from plate to grid through fields whose paths are outside the tube. Figure 1A shows how well the metal shell performs this function by completely blocking off the lines of force between the grid lead and the plate.

It is not so widely realized, however, what an effective shield the metal shell is in other respects. For one thing the metal shell has a property that is absolutely essential for good shielding; that is, it is permanently and positively grounded. This completely eliminates the sort of noise that arises sometimes in a glass-tube set when the tube shields become corroded and make poor contact between the upper and lower shield pieces. In the all-metal tube structure shown in Fig. 1B, the metal shell is connected to the grounding pin by welds that do not corrode and do not loosen.

Another shielding function performed by the metal shell which is not generally recognized is the elimination of any disturbing effect of stray electrons striking the walls of the tube. This function is performed in the glass tubes by such means as the familiar strip of graphite, on the inside of the bulb of tubes like the 6C6 and 6D6, which prevents secondary emission from the glass. In the all-metal tubes no such precautionary measure is necessary because the metal shell is a grounded conductor and the problems of charge accumulation do not arise. Because the metal shell performs as a shield so admirably in all these respects, set designers can now build stable and quiet amplifier stages having more usable gain than was ever before possible.

One feature of the all-metal tubes which means more and more to Service Men using them is their convenient and logical basing system. The aligning plug and key on the metal tube's base makes it extremely easy to insert the tube in its socket. You hold the tube over the socket so that the plug fits into the central socket hole, turn the tube until the key lines up with the slot, press, and it is done. There is no peering at the socket to find the heater holes and there is no fussing with shields.

Another convenience is the system of pin connections shown in Fig. 1C. These connections are as uniform as possible for all the types and are easy to remember.

These are only a few of the outstanding merits of the all-metal tubes.

This article has been prepared from data supplied by courtesy of RCA Manufacturing Co., Inc.—Radiotron Division.

Fig. 1. Details of metal tube construction (A and B) and pin numbers (C).

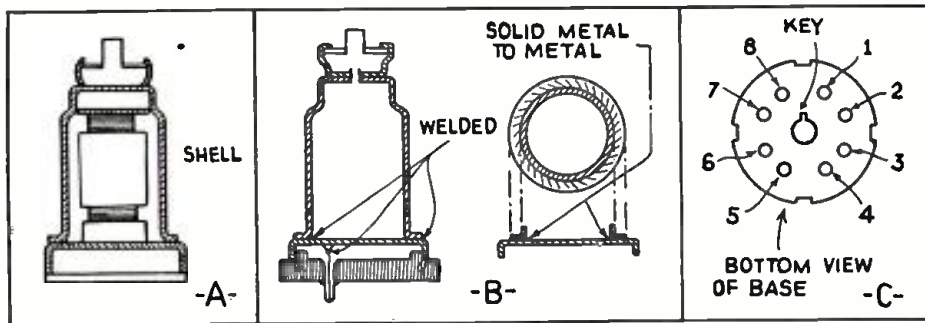

Radio Is On The Upturn... Are You?

The GOOD Men in Radio Have GOOD Jobs!

... A New Course for Experienced Servicemen:

SERVICE AND PUBLIC ADDRESS ENGINEERING

Practical right from the beginning, and priced within reach of all. This course teaches theory plus the principles of design, so that the TRAINED serviceman does better work in less time and earns more.

CREI Will Help You Get Ahead

This course STARTS where other Service Courses END. There is no waste material. The price of a stamp will bring you the facts!

CAPITOL RADIO ENGINEERING INSTITUTE
14th and Park Rd. Dept. RC-2 Washington, D. C.

There are millions of radio sets and thousands of servicemen. Yet in this prosperous, but overcrowded, field there is opportunity and money ahead for the man who is **TECHNICALLY TRAINED**. If you are ambitious, you must realize that **NOW** is the time to plan your future in a field where training pays. CREI can help YOU as we have helped others out of routine jobs into top positions in the Radio Industry.

★ **NEW 48-PAGE ILLUSTRATED BOOKLET - - - - FREE!**

MAIL THIS COUPON TODAY!

CAPITOL RADIO ENGINEERING INST.
Dept. RC-2, 14th & Park Rd., Washington, D. C.
Please send me complete details and illustrated literature regarding your new Course in Service and Public Address Engineering.

Name _____
Address _____
City _____

BOOK REVIEW

FUNDAMENTALS OF RADIO, (2nd edition) by R. R. Ramsey. Published by the Ramsey Publishing Co. 1935. Size 6x9 ins., 426 pages, cloth bound. Price \$3.50.

This book is not only adapted as a text-book for classroom work but it is also excellent for the man with a technical education because it is written in a style familiar to him. Professor Ramsey has brought this second edition up to the minute. Every phase of the subject is thoroughly treated, and the author has replaced the dead-wood found in many text books. The book is complete, well illustrated and precise. It also includes 380 problems.

Contents include: Electricity, Direct Current; Batteries; Measurement of Resistance; Alternating Current; Introduction to Radio; Capacity; Inductance; Radio Waves; Radio Current; Transmission; Detectors; Vacuum Tubes; Coupled Circuits; Aerials; Radio Resistance; Radio Telephone; Audio Amplification; Loudspeakers, etc.

THE PSYCHOLOGY OF RADIO by Cantril and Allport. Published by Harper & Brothers. Size 6 1/2 x 9 1/2 ins., 276 pages. Price \$3.00.

This volume is intended for those who are faced with problems involving the program side of broadcasting. It tells in detail the technique which is most satisfactory in putting over different types of programs, what programs appeal to various classes, and in general, every possible angle which involves the listener. Many of the conclusions reached are the results of actual experiments, and also the compilations made after study of correspondence files of the large broadcasting chains.

Those interested in the actual program material of broadcasting will find much of interest in this book.

(Continued on page 508)



This "DEPENDABLE" ANALYZER Builds Profits

YOU need this up-to-the-minute business-building Model 6423 Analyzer. Moving coil meter, accurate within 2%. 2,000 ohms per volt sensitivity. Sockets for metal and all other tubes. Self-contained 3-range ohmmeter. 4-range voltmeter. Automatic selector switches with spare points. 10-wire analyzer cable with prods. Independent metering system. "Sure Pull Out" plug adapters. Complete, ready-to-use.

ONLY \$21.95

Here's A WINNER!

New "DEPENDABLE" TUBE and SET TESTER



NEW Model 305 tests all tubes, as well as shorts and leakages above 500,000 ohms, with Neon light. Makes capacity and ohmmeter tests. Tests all types of condensers. 5" full-view fan-type "Good-Bad" meter. Separate line voltage meter. Unusually handy combination instrument, at a low price.

KIT: \$17.85
Ready-to-Use
\$21.95

Write Dept. RC-2 for New 1936 Bulletins

RADIO CITY PRODUCTS CO.
88 Park Place, New York City

New 1936 DOERLE deluxe 5-tube short-wave A.C. RECEIVER



featuring— **COMPLETE PRICE**
 ★ Range 15 to 550 Meters
 ★ Bandsread Dial
 ★ Universal Antenna Input
 ★ 8 Low-Loss Coils
 ★ Large Dynamic Speaker
 ★ Tone Control
 ★ Ready to Operate
 ★ Black Crackle Cabinet

\$27⁵³
 No. RC 5000

FREE 5-DAY TRIAL OFFER

Try this world-famous receiver in your own home for five full days. Your money promptly refunded if you are not satisfied.

Hundreds of testimonials in our files attest to the superlative performance of this wonderful set. Two tuned stages, regenerative detector, three A.E. stages with powerful pentode output and perfectly matched dynamic speaker—all contribute to place this set among the most reliable on the market. Uses 1 6D6, 1 6F7, 1 3Z5, 1 4J and 1 80. Sold complete with tubes. Say "Free 5-Day Trial" when ordering. Set of Broadest Coils, 200 to 550 meters, \$1.75 extra. Write for FREE 64-page Catalog.

RADIO TRADING CO.
 97 Hudson St. N. Y. C.

SEND FOR THIS FREE CATALOG

Check full of **BARGAINS** in **RADIO SETS**, **Long and Short Wave Apparatus**, **Service Men's Repair and Replacement Parts**, **Electrical Appliances** and **hundreds of Miscellaneous Specials** at **THE MENDOUS SAVINGS**. Get this big new Bargain Book. It's absolutely **FREE!**

without obligation—just send us your Name and address on a post card.

RADIO CIRCULAR CO., INC.
 915 Broadway, Dept. R. C., New York, N. Y.

BUILD IT YOURSELF

You can build this Trailer with ordinary tools easily from our step-by-step constructional sheets and large sized blueprints. Finest designed Trailer in existence, seats 4. Toilet, Shower, Electric Light, etc.

Save 75% of the cost by building it yourself. Send 25c for plans sheet, illustrations and details.

THE PLAN SHOP, 910 Palmolive Bldg. Chicago, Ill.

EVEREADY SERVICE CEMENT
 "The Original Speaker Cement"

This is the best cement for replacing Speaker Cones, repairing old rattling or torn cones. It can be used for other Radio work, such as sealing adjustments, cementing loose tube bases, etc. It is Vibration Proof and Fast Drying. Ask for it by name, at your jobbers. If he can not supply you, write us. Send for large circular of other Service Aids. List Price, 50c. per large bottle.

General Cement Mfg. Co., Rockford, Illinois

RADIO COURSES

RADIO OPERATING: Prepare for Gov't License Exam. ● **RADIO SERVICING:** Including Short Wave ● **AMATEUR CODE**
 ● New Course in **ELECTRONICS:** Day and Evening Classes.

Booklet Upon Request
NEW YORK YMCA SCHOOLS 4 W. 64th St. N. Y. City

"A STITCH IN TIME"

SAMUEL C. MILBOURNE

IT APPEARS to be one of the unfortunate habits of this radio industry of ours that it blindly ventures into new developments without thought of the future or how its many a time dubiously termed "improvements" reflect upon another branch of the industry.

Therefore, we wish to bring to the attention of all Service Men radio set manufacturers, and others interested in the industry, a situation which has developed recently as a result of the introduction of the new octal tubes.

It was understood by most of us that one of the original purposes of the octal tube socket was to accommodate in one single type socket, all future developed tubes, regardless of the number of elements or pins required (up to eight). This, they told us, would automatically eliminate the necessity for a multiplicity of special types of sockets and adapters, as an octal socket in which all of the eight holes are drilled would receive any octal tube.

This purpose is now being defeated by several radio manufacturers who are equipping their radio sets with octal sockets in which only those holes required for the particular tube are pierced, leaving blank the balance of the holes.

Manufacturers using the "blank out" non-standard type of socket frustrate all the laudable attempts previously made to standardize tube sockets and throw the whole situation back once more to the use of a special adapter for each type of "blanked out" socket.

Let us see what economic waste would result from these practices. There are estimated to be about 40,000 radio set analyzers in use at the present time. Looking over the types of tubes already issued, 3 special adapters are necessary at a selling price of 75 cents each. Therefore, as a result of this departure from standard procedure, the radio service industry must pay \$30,000 for adapters to service a few manufacturers' sets.

The proponents of this scheme advance as one reason that it will reduce the possibility of set owners removing a set of tubes and replacing them in the wrong sockets. We say, the set owner is not supposed to remove his tubes. A radio Service Man who is capable of correcting set troubles should be called as it is his job, and his alone.

"Let us," as a famous New Yorker says, "look at the record." All tubes will fit the 6A8 and 6P7 sockets. The 6F5, 6H6, 6J7, 6K7 and 6L7 all fit the same type sockets.

The 6C5, 6D5 and 6F5 will also fit the 6F5, 6H6, 6J7, 6K7 and 6L7 sockets, besides fitting the standard socket. The 6C5, 6D5 and 6F5 will all fit the same type socket.

The 5Y3 and 5Z4 are interchangeable as to socket, and will fit the 6A8 and 6P7 sockets.

Therefore, all 12 types fit a standard socket used by 2 tube types: 5 types are interchangeable in. let us say, special socket No. 1, 3 more types fit, let us say, special socket No. 2 and also special socket No. 1; 2 types, let us say, fit special socket No. 3.

Remember, what is needed is not the extra contacts on the tube sockets but just the extra holes pierced. Extra contacts cost money and we can see where a material saving can be made in this direction, but we are sure that it costs as much to punch 6 holes in a socket as it would cost to punch 8 holes.

We are sure that no manufacturer of test instruments wishes to make one penny through the sale of these adapters to Service Men, although, a present \$90,000 market is not to be taken lightly.

We, the Supreme Instruments Corp., suggest the following procedure to be followed by radio men:

(1) When servicing sets in which one or more "blanked out" sockets are used, replace these non-standard sockets by the standard 8 hole pierced octal sockets or drill out all blank spaces on the non-standard sockets.

(2) Immediately write the radio service organization to which he belongs to petition the R.M.A. for a standard octal socket procedure.

(3) Write his jobber or wholesaler asking him to aid in the elimination of this situation.

(4) If he represents one or more of these manufacturers who are using blanked out sockets, write them requesting an immediate abandonment of this program.

THIS MAGAZINE NEEDS NO INTRODUCTION TO SHORT-WAVE FANS

SHORT WAVE CRAFT

This popular monthly magazine, **SHORT WAVE CRAFT**, contains everything you want to know about Short Waves. The wonders of world-wide short-wave reception are clearly described and illustrated. Latest practical information for radio fans, experimenters and "hams" will be found. Tells you how to build short-wave receivers and transmitters; constant sets of one and two tubes or as many as seven, eight or more. Tells best foreign stations to log and when to tune them—includes newest and best circuits of the time. **SHORT WAVE CRAFT** is edited by Hugo Gerishback.

NEW FEATURE RECENTLY ADDED—To the short wave fan who has logged and obtained verification of the largest number of short-wave stations from all over the world during one month, will be awarded a magnificent 24" silver trophy.

Special This Month Only!

For the month of January only, we offer readers of this magazine the opportunity to read radio's greatest short-wave magazine at a special saving. The regular subscription price is \$2.50 per year. You can now get **SHORT WAVE CRAFT** for the next

8 MONTHS FOR \$1.00

4-Color Cover
 Over 200 illustrations
 9x12 inches in size

25c The Copy
 ON ALL NEWSSTANDS

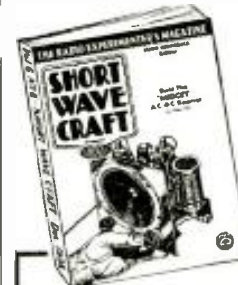

Send remittance by check, money order or U.S. Postage Stamps. Register letter if it contains cash or currency.

SHORT WAVE CRAFT
 99R Hudson St. New York, N. Y.

ELECTRIC DRILL



CAPACITY
 3/4" DRILL
WEIGHT
 4 1/2 lbs.
PRICE
\$5.97

This Utility Drill is built for intermittent service, always ready for instant use, and will accommodate straight shank drills up to 3/4 inch. Weighs only 4 1/2 pounds, and has a convenient on-and-off switch mounted on the motor body. The three-jaw chuck has a capacity up to 3/4 inch. Furnished complete with 10 feet of heavy duty rubber covered cord, and plug cap. Operates on alternating current only. 110 volts, 60 cycles.

Shipping weight 5 pounds.

OUR OLD CUSTOMERS KNOW THAT OUR MERCHANDISE IS SOLD ON A STRICT MONEY-BACK GUARANTEE.

All shipments will be forwarded by express collect if not sufficient postage included with your order.

WELLWORTH TRADING CO. RC-236
 506 Palmolive Bldg., Chicago, Ill.

Enclosed find \$..... for which ship to address below

ELECTRIC DRILL

NAME

ADDRESS

CITY..... STATE.....

Please Say That You Saw It in RADIO-CRAFT

NOW READY!

VOLUME 2 of the Official REFRIGERATION SERVICE MANUAL



\$5.00
POSTPAID

Entirely
New from
Cover to
Cover!

The Only Complete Refrigeration Service Manual Ever Published

The new volume of the OFFICIAL REFRIGERATION SERVICE MANUAL (Volume II) contains entirely new service data and information of value to everyone interested in refrigeration.

This Manual forms a companion and supplement to the previous OFFICIAL REFRIGERATION SERVICE MANUAL (Volume I), since all data in the 1935 volume are entirely new.

The curve of sales of refrigerators and replacement parts has steadily increased year by year—even during depression year. It is the one industry to make this progress. Year by year sales increase will soon place Refrigeration in rank with the automobile industry in importance.

Partial Contents in Second Volume of "Official Refrigeration Service Manual"

- Theory and Fundamental Laws
- Methods of Refrigeration
- Refrigerants, Lubricants and Brines
- Handling and Storage of Refrigerants
- Compression System of Refrigeration
- Liquid Throttle Devices
- Refrigeration Systems
- Electric Control Devices
- Compressors, Types, Seals, Valves, Capacities
- Evaporators and Cooling Units
- Service Tools
- Commercial Unit Specifications
- Servicing Refrigeration Apparatus
- Servicing Low Side Float Valve Systems
- Servicing High Side Float Valve Systems
- Servicing Expansion Valve Systems
- Servicing Thermostatic Valve Systems
- Servicing Restrictor and Capillary Tube Systems
- Charging Systems with Refrigerant
- Electrical Service: Motor, Fuses, Hookups
- Estimating Refrigeration Loads

OVER 350 PAGES
OVER 300 DIAGRAMS
Flexible, Looseleaf Binder

This New Refrigeration Manual is printed on a special Bible stock. This stock, although unusually thin, is exceptionally strong and durable. It makes handling of the book much easier.

GERNSBACK PUBLICATIONS, INC.
99 HUDSON STREET, NEW YORK, N. Y.

MAIL COUPON TODAY

GERNSBACK PUBLICATIONS, INC. RC-236
99 Hudson Street, New York, N. Y.

Gentlemen: Enclosed you will find my remittance of \$5.00, for which send me one copy of the OFFICIAL REFRIGERATION SERVICE MANUAL (Volume II). I understand that this book is to be shipped to me POSTAGE PREPAID.

Name

Address

City..... State.....

OVERSEAS READERS!

This book can be obtained from
POWER CONTRACTS, Ltd.
138 Southwark St., London, S.E.1, England

NEW DEVELOPMENTS IN ALL- WAVE RECEIVER DESIGN

(Continued from page 469)

much for radio reproduction, but it certainly is necessary for phonograph work, since here the volume expander comes into use. The expander is simply an amplifier which is so arranged that when a loud passage of sound comes through, it is amplified more than it would be in a conventional audio amplifier.

This is accomplished by a relatively simple system, as shown in Fig. 2. Here, V1 acts as a straight A.F. amplifier, the incoming signal being fed in through number 1 grid. At the same time, the signal is applied to the grid of V2 which also amplifies it. The amplified signal is then rectified by the diode-connected V3. The rectified voltage appears across R9 from which it is fed through suitable filters to the No. 3 grid of V1.

The whole arrangement operates so that when a loud passage enters V2 the resultant rectified voltage across R9 bucks the bias on grid 3 and the amplification of the tube is increased. The use of R6 allows the degree of expansion to be controlled, while Rx is the manual volume control. While in the particular set illustrated, the expander circuit is used only for the phonograph amplifier, it has been used with considerable success in high-fidelity radio receivers.

Thus it will be seen that the multiplicity of tubes in some of the large new sets actually serve useful purposes. While it is conceded that the set might work fairly well with fewer tubes, the result would not be what the discriminating buyer of such equipment expects, nowadays.

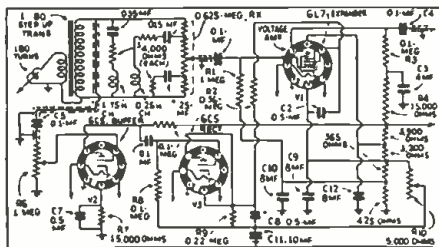

Fig. 2. The volume expander of the set.

NEW GERMAN TELEVISION RECEIVERS

(Continued from page 470)

out the future possibilities of television. Most cathode-ray television receivers of today are only bright enough to be observed in a dimly-lit room. The illumination of the screen of the new experimental set, however, is so brilliant as to permit the images to be viewed even in a brightly-illuminated room!

Another and important feature of this experimental set-up is the image definition, which may be made as high as 400 lines. (That is, image quality equivalent to that on the modern movie screen.)

This exceptional range is due to the use of a new wide-range amplifier that I have designed. It surpasses in performance the standard heretofore used—the direct-coupled amplifier. The new design permits response without serious fluctuation over a frequency range of 0.5- to 1,000,000 cycles. An important factor in securing this wide-frequency response is the arrangement of the components, as shown in Fig. C.

A PROTEST

The National Radio Service Assoc., through the medium of its official organ, the *National Technician*, has registered a strenuous protest to the so-called "Radio Manufacturers Service" sponsored by the Philco Radio and Television Corp. In a lengthy resolution, they point out in detail their grievances with this new policy. They believe it represents an attempt to monopolize a large percentage of the service business of the nation and that it tends to mislead the public into believing that the service is sponsored by radio manufacturers in general, which of course is not so.

Please Say That You Saw It in RADIO-CRAFT

NEW and SIMPLIFIED All-Wave Antenna RCA RK-40, \$5.50



Here's a genuine RCA Antenna that you can install in a few minutes. Just attach the support ropes to the two insulators and it's up. Receiver coupling unit is then attached to the binding posts of the receiver, transmission line is cut to length, and there you are. Your customer is all set to hear stations never heard before. Factory assembled, all joints soldered.

For further information write to Dept. R. C.

RCA Mfg. Co., Inc., Camden, N. J.
A subsidiary of the
RADIO CORPORATION OF AMERICA



LIBERAL ALLOWANCE MADE ON YOUR OBSOLETE INSTRUMENTS

Trade in your obsolete meter and purchase the modern service-man's Universal Tester



Volts A.C.-D.C.
5-25-100-250-1000
1000 ohms per volt

Milliamperes D.C.
1-10-100-1000

Capacity
.001-10 Mfd.
Paper or electrolytic
condensers.

Inductance
1-10,000 Henrys

D.C. Resistance
.5-5,000,000 ohms.

Send full description of obsolete instrument you wish to trade in, and 6c in stamps for Bulletin 611-PC describing the Shallcross Universal Tester.

Shallcross Mfg. Company, Collingdale, Pa.

NEW Dependable Test Equipment

Dependable OHMMETER Models 405 and 405A

DEPENDABLE OHM-METER Model 405 is an accurate double range instrument reading from 0-1,000 and 0-100,000 ohms. Measurements of less than 1/4 ohm can be made. The D'Arsonval moving coil meter has a guaranteed accuracy of 2%. Provisions are made for easily adding milliammeter and voltmeter ranges provided in Model 405A.

DEPENDABLE OHM-METER Model 405A is identical to Model 405 but has four additional voltmeter scales of 0-2.5; 0-25; 0-125 and 0-750. There are also the current ranges of 0-2.5 and 0-125 milliamperes. The panel, meter and case are the same for both models, the 405 and 405A. They are both furnished complete with self-contained batteries.



Size: 7 1/2" x 4" x 3"; Weight: 1 1/2 lbs.

Model 405—Complete, ready to operate..... **\$8.45 NET**
 Model 405A—Complete, ready to operate..... **\$9.95 NET**

Dependable MULTITESTER Model 403-A



Service men and dealers highly praised the Model 403 Multitester—and it deserved praise. But the new improved Model 403-A "DEPENDABLE" MULTITESTER insures even greater satisfaction at less cost. Embodying every feature of the former model, No. 403-A is more compact, having been designed as a companion instrument to the new Model 501 ANALYZER UNIT.

2,000 ohms per volt. Accuracy within 2 per cent in D'ARSONVAL type moving coil meter. 3-range 0-2,000,000 ohm-meter; 4-range 0-5-50-250-750 voltmeter; 0-500 microammeter.

COMPLETE, READY TO OPERATE
\$13.95 Net
 In Kit Form **\$10.65**

Dependable POWER LEVEL INDICATOR Model 421



Complete: \$25.85—Kit: \$21.00

Important help for P.A. men. Measures power levels from minus 12 to plus 43 decibels. Highly-accurate 5" fan-type meter calibrated from down 12 to up 10 decibels. 500 microamp. movement. Knife-edge pointer. Unique 10,000 ohm constant impedance L-type attenuator. Also direct-reading, 4-range A.C. voltmeter for all frequencies.

We Issue All orders are F.O.B. New York. Terms: No Catalog A deposit of 20% is required with every order. Balance may be paid on delivery. DEDUCT 2% IF FULL AMOUNT IS SENT.

GRENPARK COMPANY
 101 Hudson St. Dept. RC New York, N. Y.

AN A.C.-D.C. BEGINNER'S SUPER. "2"

(Continued from page 477)

that constitutes the front face of the loud-speaker. This construction will permit the entire chassis to be fitted into a midget cabinet; and the reproducer to fit tightly against the cabinet grille. (A different reproducer may necessitate a different value for C7.)

Make sure that the coil connections of L1, and L2-I.F.T. are correct as per the detail illustration given, and the schematic circuit. The lead marked "brown" is a tap that the experimenter must take from the common connection between the two primaries of the composite coil. Lead "black" is a lead inside the composite unit that must be shifted; in the commercial coil this wire is grounded, and must be unsoldered from its grounding point and swung over to terminal 3. It is possible that an improvement will result by reversing at X-X leads 5-6 of the L1 tickler coil (which slips inside the secondary). Another reversal of connections at X-X, leads "red" and "1," may improve operation.

The L1 tickler coil is made by winding any fine wire (about No. 30, insulated) on a form that will just slip inside the L1 secondary; the exact number of turns, and the location of the coil are determined by experiment—in general, about 50 to 75 turns will be sufficient, with the coil so positioned inside the secondary as to secure regeneration with a midway to 3/4-on setting of R1, at the highest-wavelength setting of C1.

It is preferable to use a service oscillator to align the circuits. However, the manufactured, "composite" (combination) coil, L2-I.F.T., is made to such close tolerances that the correct settings for trimmers C3 and C4 may be taken as their half-way adjustment. With this as a starting point the trimmers in shunt to C1 and C2 are adjusted for maximum signal strength from a local broadcast station, with regeneration controls R1 and R2 adjusted for least regeneration consistent with good reception. After this, the C1 and C2 circuits may be checked, at 200- and 545-meter (approx.) settings, when listening to distant stations.

The experimenter who wishes to secure increased sensitivity may wish to use a 10,000- to 20,000-ohm bare-wire voltage divider as R7-R8, moving the slider along the resistor until the optimum voltage is secured for the screen-grid of tube V1. This expedient will take care of individual tube characteristics.

Note that the only way in which the external ground makes connection to the set is capacitatively through condenser C8. This is a safety measure in D.C. power line operation; the fused line plug is an additional safeguard (that should be included in all sets designed to operate on D. C. lines). The tuning condenser unit has a 3/8-in. shaft, requiring a dial or indicator-knob with this inside diameter; or, a 1/4-in.- to 3/8-in. reducing adapter may be used.

LIST OF PARTS

- *One kit of 456 kc. superhet. shielded coils, L1 (with tickler), L2-I.F.T.;
- One Electrad 50,000-ohm tapered volume control, R1, with switch Sw.1;
- One Electrad 10,000 ohm tapered volume control, R2;
- Two Aerovox resistors, 2 meg., 1 W., R3, R4;
- One Aerovox resistor, 0.1-meg., 1 W., R5;
- One Aerovox resistor, 1 meg., 1 W., R6;
- One Electrad resistor, 2,500 ohms, 2 W., R7;
- One Electrad resistor, 7,500 ohms, 2 W., R8;
- One Aerovox resistor, 1,100 ohms, 2 W., R9;
- *One 2-gang 365 mmf. variable condenser, with 456 kc. tracking section, C1, C2;
- One Cornell-Dubilier 0.1-mf. paper cond., C5;
- One Cornell-Dubilier 100 mmf. paper cond., C6;
- *Manufacturer's name upon request.

Coil connections for L1 and L2.

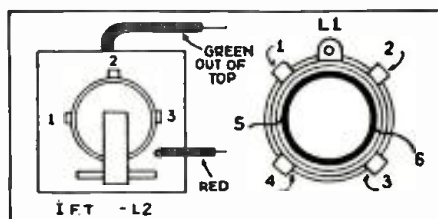

TYPEWRITER BARGAIN

10-DAY FREE TRIAL OFFER

FREE HOME TYPING COURSE



ONLY 10¢ A DAY

BRAND NEW MODEL No. 5

REMINGTON PORTABLE

● A brand new Remington for only 10c a day. An easy, practical Home Typing Course FREE. With it anyone quickly becomes expert on this machine... the most rugged, dependable portable made. Not used or rebuilt. Standard 4-row keyboard. Standard width carriage. Margin release on keyboard. Back spacer. Automatic ribbon reverse. Every essential feature of big office typewriters. Carrying Case FREE. Try it for 10 days without risking a cent. If you don't agree it is the finest portable at any price, return it at our expense. Don't delay. Without obligation, write now. Remington Rand Inc., Dept. 189-2, 205 East 42nd Street, New York, N.Y.

CLASSIFIED ADVERTISEMENTS

Advertisements in this section are inserted at the cost of twelve cents per word for each insertion—name, initials and address each count as one word. Cash should accompany all classified advertisements unless placed by a recognized advertising agency. No less than ten words are accepted. Advertising for the March, 1936, issue should be received not later than January 6, 1936.

A.C. AUTO GENERATORS

TWENTY PRACTICAL AND LOW-COST CHANGES converting old generators into new generators and motors 100-500 watt capacity, dc or ac current, with 6 to 400 volts, for radio operation, power, light, or welding. Also instructions for rewinding armatures. 350 definitions of electrical terms, etc. All in new, revised book with simplified instructions and illustrations. Endorsed by thousands. Only \$1.00 postpaid. Autopower, 414-C S. Hoynes Ave., Chicago.

RADIO

RADIO ENGINEERING, BROADCASTING, AVIATION and police radio, servicing, Marine and Morse Telegraph taught thoroughly. All expenses low. Catalog free. Dodge's Institute, Pine Street, Valparaiso, Indiana.

TRADE YOUR USED TEST EQUIPMENT ON NEW latest models Supreme, Trip, et, Weston, RCA Oscilloscope, etc. Liberal allowance, lowest prices. Lyon-Watt Radio, Wichita, Kansas.

"RADIO BUILDER"—25¢ YEAR 36 CRYSTAL SET; Shortwave ideas; blueprints. Sample free. Laboratories, 151-B Liberty, San Francisco.

FREE

OFFICIAL RADIO BARGAIN CATALOG
1935
RADIO TRADING CO.
OFFICIAL DOERLE SHORT-WAVE RECEIVERS

IMPORTANT ILLUSTRATED BUYING GUIDE FOR RADIO EXPERIMENTERS. SERVICE MEN, AND SHORT-WAVE FANS.—32 Pages—Two Colors—Profusely Illustrated This Book Will Save You Money!

Packed between the covers of this 32-page book is a tremendous array of modern radio equipment and other electrical and scientific merchandise—the very material for which you have been looking—and at prices which cannot possibly be any lower.

Radios and parts, low priced microphones, automobile radio sets, complete public address equipment, field glasses, the finest short-wave equipment available, crystal receivers, radio replacement parts, etc., etc. Name the item—and it's in the book! This amazing book will show you how to save money. You save by buying at the lowest possible prices. Why not start saving now? Don't delay! Write today! Send postcard or letter. Book by return mail. It's free!

RADIO TRADING COMPANY
97 Hudson Street, New York, N. Y.

Please Say That You Saw It in RADIO-CRAFT

12 BOOKS TO HELP YOU LEARN MORE ABOUT RADIO

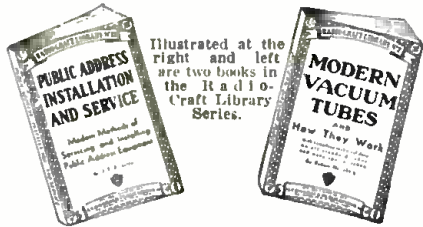

Illustrated at the right and left are two books in the Radio-Craft Library Series.

THE RADIO-CRAFT LIBRARY SERIES—a most complete and authentic set of volumes—treats individually, important divisions of radio. Each book has been designed to give you the opportunity to learn one or more branches of radio. The authors of the books are well-known to everyone. Each is an expert radio man; an authority on the subject—each is thoroughly familiar with the field which he represents.

All Books Uniform

The volumes in the RADIO-CRAFT LIBRARY SERIES are all uniform, 6 x 9 inches. Each book contains on an average of 50 to 120 illustrations. The books are printed on an excellent grade of paper which makes the type easy reading.

Here Are the Series:

- Book No. 1
RADIO SET ANALYZERS
And How to Use Them By L. VAN DER MEL
- Book No. 2
MODERN VACUUM TUBES
And How They Work By ROBERT HERTZBERG
- Book No. 4
MODERN RADIO HOOK-UPS
The Best Radio Circuits By R. D. WASHBURNE
- Book No. 5
HOW TO BECOME A RADIO SERVICE MAN
By LOUIS MARTIN
- Book No. 6
BRINGING ELECTRIC SETS UP TO DATE
By CLIFFORD E. DENTON
- Book No. 7
RADIO KINKS AND WRINKLES
For Service Men and Experimenters
By C. W. PALMER
- Book No. 8
RADIO QUESTIONS AND ANSWERS
By R. D. WASHBURNE
- Book No. 9
AUTOMOBILE RADIO AND SERVICING
By LOUIS MARTIN
- Book No. 10
HOME RECORDING AND ALL ABOUT IT
By GEORGE J. SALIBA
- Book No. 11
POINT-TO-POINT RESISTANCE MEASUREMENTS
By CLIFFORD E. DENTON
- Book No. 12
PUBLIC ADDRESS INSTALLATION AND SERVICE
By J. T. BERNSELY

BIG DISCOUNT OFFERED

When Five (5) Books or More Are Ordered, Deduct 20% from Your Remittance

GERNSBACK PUBLICATIONS, INC.
99 Hudson Street, New York, N. Y.

MAIL THIS COUPON TODAY!

GERNSBACK PUBLICATIONS, INC.
99 Hudson Street, New York, N. Y.

I have circled below the numbers of books in the RADIO-CRAFT LIBRARY SERIES which you are to send me, and have deducted 20% for ordering five (5) books or more. I have included my remittance in full, at the price of 50c each, when less than five books are ordered.

The amount of my remittance is.....
(stamps, checks or money orders accepted). Circle numbers wanted:

1 2 3 4 5 6 7 8 9 10 11 12

Name

Address

City State

All books are sent postage prepaid
RC-236

- One Cornell-Dubilier .005-mf. paper condenser, C7;
- One Cornell-Dubilier 0.1-mf. paper condenser, C8;
- Two Aerovox 250 mmf. mica condensers, C9, C10;
- One Cornell-Dubilier .05-mf. paper condenser, C11;
- One Cornell-Dubilier paper condenser, 0.1-mf., C12;
- One Aerovox electrolytic condenser, 35 mmf., C13;
- One Solar "Little Giant" dual electrolytic condenser, 8-8 mf., C14, C15;
- One Acratest 25 mhy. R.F. choke, RFC.;
- One National Union or RCA type 6F7 tube, V1;
- One National Union or Sylvania type 12A7 tube, V2;
- Two Acratest 7-prong sockets, for V1 and V2;
- One Acratest 5-in. magnetic reproducer;
- One Alloy Transformer midget low-resistance A.C.-D.C. choke, 100 ohms. Ch.;
- One Blan power cord, with built-in 346-ohm resistor, R10;
- One Blan fused plug;
- Two Blan tip-jacks (one black and one red. for phones);
- Hardware (wire, knobs, etc.).

LATEST RADIO EQUIPMENT

(Continued from page 499)

This book is priced at 50c and can be obtained by writing to Raytheon Production Corp. in care of this magazine. Ask for No. 918.

The second book gives a full description of a 36 W. P.A. amplifier including the circuit, layout and a complete outline of operating it.

The amplifier is a high-fidelity unit, particularly adapted for permanent P.A. installations where medium output is required. The book explains in detail the various steps in constructing the unit as well as operating it. This includes not only the amplifier itself, but the components such as microphone, speakers, phono. equipment, etc., which is used with it.

The Service Man and P.A. man will find this little book unusually interesting.

This book can be obtained by writing to the Radolek Co. in care of this magazine. Ask for No. 919.

NEON OUTPUT INDICATOR (920)

(Globe Mfg. Co.)

Service Men will be interested in this economical output meter, which operates on the neon lamp principal. It is housed in a compact case with a panel upon which is placed the control knob and scale, and the terminals. Connection is made directly to the voice coil of the speaker.

PARABOLIC BAFFLE (921)

(Hope Manufacturing Co.)

This new type of baffle designed for sound work of all types utilizes the highly efficient parabolic type reflector as its basis form.

The baffle is made of aluminum and completely encloses the dynamic speaker from which the sound is projected. The use of this type of baffle provides a more efficient sound coverage in the desired direction, due to the greater efficiency of reflection produced by the parabolic shape of the flare. It also protects the speaker unit, since it completely surrounds it.

This new type of baffle is made to fasten to the wall or ceiling or it may be mounted on a portable stand so that it can be placed in any desired position or direction. The speaker can be tilted to any desired angle to produce the most effective sound coverage. Two sizes of baffles hold 7 or 10 in. speakers.

The aluminum baffle and speaker (921) Output indicator (920)

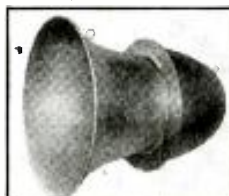

Radio Parts Specialists

Supplying 20,000 Servicemen With Everything in Radio



The New Radolek 1936 Profit Guide is NEW! BIGGER! BETTER! The most complete Radio Parts Catalog ever published—it's colossal—gigantic—it's the "top"! Never has there been a Radio Parts Catalog comparable to this superb book. Every page brings you extra profits. Completely revised—right up to the minute, bringing you everything in radio—at the right prices. Over 160 pages of valuable, money-saving "radio-buying" information. Over 10,000 separate Repair Parts—hundreds of new items—a complete, new selection of Radio Receivers and Amplifiers. Contains the most complete, exact duplicate, replacement parts listings of volume controls, condensers, transformers, vibrators ever compiled. This is your book—it's FREE. Send for IT!

RADOLEK restricts distribution of the PROFIT GUIDE to those actively and commercially engaged in the Radio Business. Please enclose your Business Card or Letter Head.

MAIL THIS COUPON!

THE RADOLEK CO.
564 West Randolph Street Chicago, Ill.

Send me FREE the Big New RADOLEK PROFIT GUIDE.

Name

Address

Are you a Service Man Dealer Expm.?

READ AND SEND CODE

Learn Easily at Home This Quicker Way

No experience needed. Beginners read code quickly, copy accurately. If already an op, speed up your wpm with this amazing improved Master Teleplex. Only instrument ever produced which records your sending in visible dots and dashes on embossed copper tapes—then sends back your own key work. Fascinating, fool-proof—gets results because you learn by HEARING as well as SEEING. Teleplex has taught the code to more students in past few years than all other methods combined. We furnish complete course, lend you the New Master Teleplex, and personal instruction with a MONEY-BACK GUARANTEE. Low cost, easy terms. Write today for folder A-2, no obligation.

TELEPLEX COMPANY
76 Cortlandt St.
New York, N. Y.
MASTER TELEPLEX—"The Choice of Those Who Know"



QUALITY recommends

Condensers by

WET • DRY
PAPER
MICA ••• TRIMMER



SOLAR MFG. CORP. 595-601 Broadway New York City

Please Say That You Saw It in RADIO-CRAFT

**MOTOR DRIVEN
Craftsman Tools
COMPLETE—READY TO RUN**

ELECTRIC HANDY-LATHE



PRICE
\$757

Shipping Weight
10 lbs.

WITH BUILT-IN MOTOR

Length of Bed, 15 inches; height to spindle, 2 inches, is supplied with face plate as well as spur center for handling all types of work. This lathe is furnished with a built-in Induction Motor, mounted on the head-stock, so that the drive wheel acts directly on the three-speed pulley. **NO BELT REQUIRED.** In shifting to the various speeds it is only necessary to lift the motor with the left hand and slide it forward or back as desired. A finger-tip switch is located conveniently on top of the motor. Finished in gray and green enamel and comes complete with motor, cord and plug cap, and special wrench. Operates on alternating current only, 110 volts, 60 cycles.

ELECTRIC GRINDER



PRICE
\$349

Shipping Weight
4 lbs.

Comes supplied with 2 genuine Aloxite grinding wheels, one coarse grinder, and one fine grinder. It is driven with a

dependable induction type high speed inner fan cooled motor with the grinding wheels mounted at opposite ends of the motor shaft. This motor does not interfere with radio reception, and has a heavy ground steel shaft and large bronze bearings, having thick felt oil-retaining washers behind them, constantly lubricating the shaft and bearings and provided with oil holes for re-oiling. Complete with cord and plug cap. Operates on alternating current only, 110 volts, 60 cycles.

ELECTRIC SCROLL AND JIG SAW



PRICE
\$469

Shipping Weight
10 lbs.

This is an entirely new type of saw, powered by a fan-cooled, induction motor geared directly to saw blade for maximum power.

Blade stroke $\frac{3}{4}$ ". Made of channeled steel, has 12" throat that handles work up to 24" long, $6\frac{1}{2}$ " round work table, adjustable hold down shoe with guide roller to support and steady saw blade. Cord, plug and 1 blade included. Built-in motor operates on alternating current only, 110 volts, 60 cycles.

Our Old Customers Know That Our Merchandise Is Sold on a Strict Money-Back Guarantee

All Shipments will be forwarded by Express Collect if not sufficient postage included with your order.

WELLWORTH TRADING CO.
506 Palmolive Bldg., Dept. R. C. 236, Chicago, Ill.

BOOK REVIEW

(Continued from page 503)

MAKING A LIVING IN RADIO, by Zeh Bouck. Published by McGraw-Hill Book Co., 1935. Size 6 x 8 $\frac{1}{4}$ ins. 222 pages. Price, \$2.00.

Here is a book written for the man who wants to "get into radio" but doesn't know just how to go about it. It is also directed at those who are in and want to better themselves. It is written very candidly and will serve to dispel some of the false illusions brought about by advertisements of the less reliable radio schools.

Both the technical and the non-technical sides of the industry are discussed, and it is certain that those interested in a radio career will find much of benefit in this new volume.

THEORY OF ALTERNATING CURRENT WAVE-FORMS by Philip Kemp. Published by Instruments Publishing Co., 1935. Size 6 x 8 $\frac{3}{4}$ ins. 218 pages.

This monograph is intended to present to the reader already familiar with alternating current theory, the facts relating to non-sinusoidal waves. The subject is treated without reference to any specific apparatus as far as possible.

The author states that while some of the material included is generally available, it is so widely scattered that the student would have great difficulty in rounding it up. He has therefore compiled this study, and included a valuable bibliography for those who wish to pursue the subject further.

TELEVISION-THEORY AND PRACTICE, by J. H. Reyner. Published by the Sherwood Press, 1935. Size 6 x 9 ins., 196 pages.

This book treats television in its true light, that of a science which does not hesitate to face difficulties and to assess facts at their true value. As far as possible the subject has been considered from the first principles and an attempt has been made to convey fundamental information which will be of real value to the student of the subject. All of the systems used in America and Europe are fully covered by text and illustrations. The book is well written by one who understands the subject, and it is profusely illustrated.

Something NEW!

WEATHER FORECASTER AND HUMIDITY TESTER



"HYGROSCOPE"

The Ace of Weather Forecasters

When placed in a well-ventilated room or in the fresh air, the HYGROSCOPE foretells coming weather conditions from eight to twenty-four hours in advance. It also accurately records outdoor humidity, and when placed inside it gives the humidity within the house or room.

The HYGROSCOPE is automatic self-adjustable, simple American-precision made. It cannot get out of order at any time. The dial measures 2 $\frac{3}{4}$ ", is enclosed in a 6" round hardwood case, with either walnut or mahogany finish. It is attractive for desk or living room.

OUTSIDE DIAL FORECASTS WEATHER

Fair—rain—or changeable is indicated on the outer dial when the HYGROSCOPE is placed in a well-ventilated room or out-of-doors. If indoors, place the instrument near an open window.

INNER DIAL SHOWS THE HUMIDITY CONTENT

The HYGROSCOPE also acts as a hygrometer. Numbers on the inner dial indicate the degree of humidity present in the air and in artificially heated rooms.

SEND YOUR ORDER NOW! Get your HYGROSCOPE today. Your remittance in form of check or money order accepted. If you send cash or unused U. S. Postage Stamps, be sure to register your letter. Also specify if you prefer the HYGROSCOPE in Walnut or Mahogany. **\$2.00** Postpaid

GREN PARK COMPANY

Dept. RC-236
99 Hudson St. - New York, N. Y.

Advertiser's Index

A	N
Aerovox Corporation..... 494	National Radio Institute..... 451
Allied Radio Corp..... 501	National Union Radio Corp..... 492
Alloy Transformer Corp..... 498	New York YMCA Schools..... 504
Amperite Corporation..... 488, 502	O
Arrow Sales Corporation..... 502	Oxford Radio Company..... 495
The Automatic Electrical Devices Co..... 495	P
B	The Plan Shop..... 504
The Brush Development Co..... 494	Popular Book Corp..... 504
C	Precision Apparatus Corp..... 509
Capitol Radio Engineering Institute..... 503	R
Central Radio Laboratories..... 488	Radio & Technical Publ. Co..... 499
Classified Section..... 506	Radio & Television Institute..... 496
Coast-to-Coast Radio Corp..... 496	Radio Circular Company..... 504
Columbia Sound Co., Inc..... 498	Radio City Products Co..... 503
Commercialite Laboratories..... 502	Radio Construction Labs..... 500
Consolidated Radio Products Co..... 502	Radio Publications..... 501, 502
Continental Carbon, Inc..... 500	Radio Trading Company..... 504, 506
Cornell-Dubilier Corp..... 487	Radio Training Assoc. of America..... 492
Coyne Electrical School..... 449	Radolek Company..... 507
D	Raytheon Production Corp..... 497
Tobe Deutschmann Corporation..... 509	RCA Institutes, Inc..... 502
Dodge's Institute..... 500	RCA Mfg. Company, Inc..... 505
E	Readrite Meter Works..... 485
Hugh H. Eby, Inc..... 486	Remington Rand, Inc..... 506
Eilen Radio Laboratories..... 509	S
Electrad, Inc..... 491	S. O. S. Corporation..... 496
Electric Institute..... 452A	Sears, Roebuck & Co..... 498
F	Servicemen's Publishing Co..... 502
Freed Radio Company..... 500	Shallcross Mfg. Company..... 505
G	Solar Mfg. Company..... 507
General Cement Mfg. Company..... 504	Sound Apparatus Company..... 500
General Electric Company..... Back Cover	F. L. Sprayberry School..... 490
General Transformer Corp..... 487	Sprayberry Academy of Radio..... 487
Goldentone Radio Company..... 496	Sprague Products Co..... 496
Grenpark Company..... 506, 508	Standard Transformer Corp..... 491
H	Supreme Instruments Corp.....
Hammarlund Mfg. Company..... 498Inside Front Cover
Hygrade-Sylvania Corp..... 489	T
I	Teleplex Company..... 507
Inter-World Trade Corp..... 500	Thor Radio Company..... 495
L	Triplett Electrical Instrument Co..... 483
Lincoln Engineering School..... 498	W
Arthur H. Lynch, Inc..... 502	The Webster Company..... 486
M	Wellworth Trading Company..... 504, 508
Midwest Radio Corp..... Inside Back Cover	Wholesale Radio Service Co., Inc..... 493
	Wright-DeCoster, Inc..... 490

Please Say That You Saw It in RADIO-CRAFT

NEW METAL-TUBE CHASSIS SIMPLIFIES "MODERNIZING" OLD SETS

(Continued from page 474)

pert, and only a few pertinent observations need be made.

The Service Man's first step in modernization is to determine exactly the type of modernization he will employ, and, upon this, base his cost estimate. There are several possible variations:

(1) Complete modernization, using the replacement chassis (designed by Glenn H. Brown) and speaker, and scrapping the entire "works" of the old set. This is the simplest method, and, in many instances it may be the most economical.

(2) Retaining the old speaker only.

(3) Retaining the entire audio system and power supply.

(4) Retaining the power stage only, power supply and speaker.

(5) Retaining the power supply only.

It is not practical to operate the old audio system from the replacement power supply. While it is designed with a liberal factor of safety, this would be impaired with the extra load imposed by the additional tubes.

COST FACTORS

Retaining the old speaker only, may not always effect an economy, for, while a \$4.10 item (the speaker) is eliminated, a 70-ma., 30-hy. choke may have to be added, plus a series resistor capable of carrying the same current, and of a value to bring the resistance of the combination which is substituted for the speaker field, to 1,800 ohms. Also, a special impedance-matching transformer will be necessary in many instances.

Where it seems preferable to retain the power supply, speaker and power stage, the above arrangement can be used only if the power stage is a pentode. The output of the diode detector is not sufficient to swing a class A power stage—for instance, two 45s in push-pull. In the case of the class A power stage, the 2A5 or 42 should be used in the replacement chassis as a class A amplifier by connecting the screen-grid to the plate. The output impedance then approximates that of a 27, and can be coupled through any transformer having the correct impedance—approximately 7,000 ohms.

In retaining the old power supply only, the speaker field must, of course, be included in the plate current circuit, in series with or by substitution for part or all of the original choke system.

General Motors model 120 Highboy. A typical example of bringing a fine old receiver up-to-date is found in the modernization of the General Motors model 120 highboy. In this set, the original reproducer was retained. The chassis and speaker are first removed, followed with the chassis shelf which is fastened with 4 wood screws to side cleats. The original panel held to the cabinet with wood screws, is also taken out, to be replaced with a ply or solid wood panel cut to fit. This panel is drilled to accommodate the replacement chassis and is mounted on the chassis by means of the manual-automatic volume control switch and the I.F. sensitivity-volume control. The main volume control and off-on switch are mounted. The escutcheon is fastened to the panel with the nuts and bolts provided for this purpose. After the bolts are tightened (and the pointer



YOUR OBSOLETE ANALYZER MODERNIZED!

INTO A TWO METER MASTER ROTARY SELECTIVE SYSTEM

WRITE FOR OUR PLAN { MENTION MODEL NUMBER OF YOUR OLD ANALYZER

PRECISION APPARATUS CORP.

821 EAST NEW YORK AVENUE Modernization Division—Dept. C BROOKLYN, NEW YORK

mounted), the dial card, which was previously punched (using the escutcheon as a template), is slipped over the projecting bolts and secured with the 3 extra bolts. Due to the large opening in the shelf, strips were built on to accommodate the replacement chassis. No cushioning was found necessary in this installation.

The reproducer plug in the original installation fits the replacement chassis. It was only necessary to disconnect the center tap of the speaker field in the speaker cable before replacing the loudspeaker.

Majestic Model 91. This receiver, manufactured in 1928 and 1929, presents an excellent example of what can be done in the way of salvaging a considerable portion of the original installation. Both the reproducer and the power-pack were retained, with the following electrical alterations to adapt them to the replacement chassis: As the output transformer on the original receiver is integral with the tuning chassis, a new transformer was provided, having primary and secondary impedances of 8,000 and 4 ohms, respectively. The high plate voltage is fed to the replacement chassis through a 1,200-ohm, 5-W. resistor (from the red lead). A bleeder resistor of 7,000 ohms, 5-W. rating, is connected between the original Majestic R.F. tube high-voltage tap (yellow), and ground, to supply field excitation for the speaker. The center-tap filament winding is not employed, and the higher current winding, with the 2 blue leads, supplies current to the heaters.

MODERNIZATION WITH METAL TUBES

Many potential customers for modernization jobs may request the use of metal tubes as a result of the publicity which has been accorded this development. The engineering that has gone into design of the replacement chassis is such as to anticipate any reasonable changes in tube structure, and such features as the metal tubes may have to offer can be taken full advantage of in this receiver.

The diagram of the replacement chassis with metal tubes is shown in Fig. C. Theoretically there has been no change in the circuit. It has been merely necessary to substitute 2 tubes for the 2A6 or 75, performing exactly the same functions as were effected by the dual-purpose tube.

This article has been prepared from data supplied by courtesy of Tobe Deutschmann Corp.

The circuit of the Browning 35 chassis revised for metal tubes as explained above.

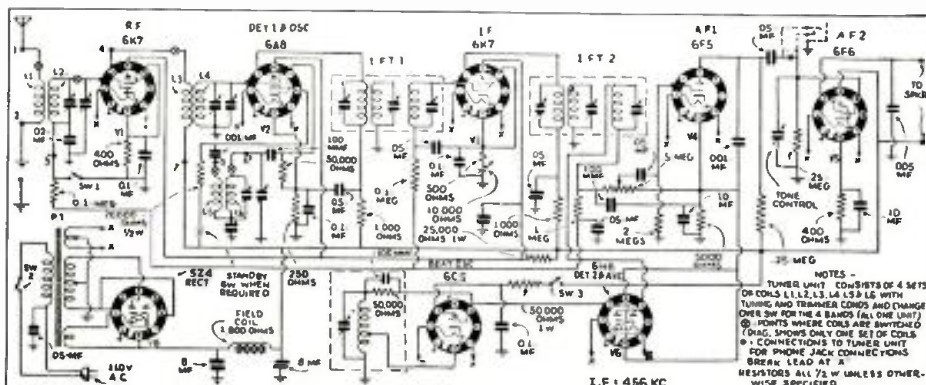

NEW Sets for OLD! AT 1/3 THE COST

A sensational new idea now makes it possible for you to own a custom built radio at a fraction of the cost of a factory built model of equal performance! Why discard your present radio when the cabinet and much of the equipment can be utilized in an up-to-the-minute circuit which brings you superlative world-wide all-wave reception? Other features include: automatic volume control, highest sensitivity and selectivity, etc. Your own radio serviceman is undoubtedly a Tobe Modernization Engineer. Tear out this ad and ask him about it. You'll be amazed when he gives you a price for modernizing your receiver. If he cannot—write for name of the nearest Tobe Modernization Engineer.

SERVICEMEN! DEALERS!

If you have not already done so, get a copy of Zeh Bouck's book on this new phase of radio Servicing. Nearly 1000 servicemen have already entered this field. Write today for Book and Free Merchandising Plan and Sales Promotion Kit.

Tobe Deutschmann Corp., Dept. C 26 Canton, Massachusetts

I am a customer serviceman
 Send me name of nearest Tobe Modernization Engineer. I own a 19... receiver.
 I enclose 25c for Zeh Bouck's Book and Free Sales Promotion Kit.

Name
 Address
 City..... State.....

Eilen HG-36 5-TUBE RECEIVER



A powerful, custom built, receiver that will produce enormous volume on foreign SW stations under good conditions. Uses 6D6-6CG-76-42-84 tubes as Tuned RF amp., screen grid regenerative detector, powerful 2 stage audio amplifier, rectifier and power supply. Built-in dynamic speaker. Special BANDSPREAD airplane type illuminated dial. Sold on money back guarantee.

KIT of parts, with 8 coils for 10-200 meters and simple \$14.95
 8 coils for 10-200 meters, receiver and cabinet
 Black arched finished cabinet 2.50
 5 Arceturus tubes 2.85
SPECIAL: Complete kit, cabinet, 5 Arceturus tubes and 8 coils for 10-200 meters **\$18.95**

Labor for wiring and testkit, extra 2.00
 Broadband hand coils, extra 1.45
NOTE: If metal tubes are desired (6K7-6J7-6CS-6F6-84) add \$1.50 to tube price.

EILEN RADIO LABORATORIES
 High Grade Short Wave Equipment, 136 Liberty St., New York, N.Y.

Please Say That You Saw It in RADIO-CRAFT

Be Prepared to Meet All Radio Servicing Emergencies

WITH GERNSBACK OFFICIAL RADIO SERVICE MANUALS



Just as we say—"Be prepared to meet all radio servicing emergencies with the Gernsback Official Radio Service Manuals." You never know when a service job requires that "extra" special attention. It might mean the difference between doing the job or losing it. You're safe if you have on hand the GERNSBACK MANUALS—either for regular service work or for servicing auto-radios. Get your copy today!

No other radio book is comparable to the new 1935 OFFICIAL RADIO SERVICE MANUAL. In contents, in style of printing, in grade of paper, in illustrations, there has never been published such a comprehensive volume.

This Manual contains over a thousand pages—yet it is only 1 1/4 inches thick because it is printed on a special Bible stock which is an exceptionally good stock, yet one of the thinnest and most durable papers. This 1935 Manual is the most authentic and elaborate service guide ever used in the radio industry.

Contents of the 1935 Manual

Over 1,000 pages full of diagrams and essential information of manufactured receivers—only data of real use in servicing is included. This new Manual is really portable since it is extremely thin and light as well. • Volume V continues where the preceding manual left off. • Many circuits of old sets are included. • Service Men know every set has certain weak points which are really the cause of trouble. Wherever the information could be obtained, these weaknesses with their cures are printed right with the circuits. This is an entirely new and valuable addition to the Manual. • All the latest receivers are included—all-wave sets, short-wave sets, auto-radio sets, midjet and cigar-box sets, etc., as well as P.A. Amplifiers and equipment,

and commercial servicing instruments. • The cumulative index is even more complete than before; including cross-references to sets sold under different names and type numbers. • Volume V includes resistance data; socket layouts; I.F. data; and voltage data. • Tube data on latest tubes. • Free question and answer service—as included in our last three manuals.

OVER 1000 PAGES

Over 3,000 Illustrations
Size 9" x 12"—only 1 1/4" thick
Flexible, looseleaf leatherette cover

SET SERVICING
 Service information found in the Manuals covers all types of radio receivers. The material is extremely valuable to Dealers and Service Men. On many diagrams appear voltage readings of tubes, socket connections, transformer data, alignment details, and other service notes.

PUBLIC ADDRESS
 The pages on P.A. Installation will be helpful to Service Men and P.A. specialists. Such prominent features as class A and B amplifiers—single and dual channel systems—attenuators, and mixers—superpower stages—preamplifiers and other commercial devices for P.A. work are included.

ALL WAVE RECEIVERS
 Information relative to short-wave receivers have found their way into the Manuals. For these standard manufactured sets, wherever possible, complete aligning details for all wave bands are included in addition to the service material listed for other sets.

AUTO-RADIO RECEIVERS
 All available service information on new auto-radio sets has been included. From this data alone Service Men could derive sufficient knowledge to venture in a specialty field—that of servicing only auto-radios.

\$7.00
 List

Which of These GERNSBACK RADIO SERVICE MANUALS

Do You Need to Complete Your Files?

1934 Official Radio Service Manual
 Over 400 Pages. 9x12 Inches.
 Over 2,000 Illustrations
 Flexible, Looseleaf. Leatherette Cover
 List Price \$3.50

1933 Official Radio Service Manual
 Over 700 Pages. 9x12 Inches.
 Over 2,000 Illustrations.
 Flexible, Looseleaf. Leatherette Cover
 List Price \$5.00

1932 Official Radio Service Manual
 Over 1,000 Pages. 9x12 Inches.
 Over 2,000 Illustrations
 Flexible, Looseleaf. Leatherette Cover
 List Price \$5.00

1931 Official Radio Service Manual
 650 Pages (Including Supplements)
 9x12 Inches
 Over 1,500 Illustrations
 Flexible, Looseleaf. Leatherette Cover
 List Price \$4.50
 (Including Supplements)

1933 Official Auto-Radio Service Manual
 (Volume I)
 Over 200 Pages. 9x12 Inches.
 Over 500 Illustrations.
 Flexible, Looseleaf. Leatherette Cover
 List Price \$2.50

—for the real auto-radio servicing "dope," you can't find a better book!

The 1935 Official Auto-Radio Service Manual

Every radio man connected in any way with the booming auto-radio business needs a copy of the new OFFICIAL AUTO-RADIO SERVICE MANUAL. It contains only auto-radio service "dope."

HERE ARE HIGHLIGHTS OF THE 1935 AUTO-RADIO SERVICE MANUAL

240 pages crowded with diagrams, service material and other essential data required for proper servicing of new auto-radio receivers. Included are diagrams of sets which appeared during 1934, and which were not included in the supplement to the first edition. Complete schematic diagrams, chassis layouts, voltage tabulations and servicing instructions are included for practically all sets. "Under side" tube symbols are also included to facilitate the job of servicing the sets.

Instructions are included with many sets telling how to suppress stubborn cases of ignition interference. This includes the newest "suppressionless" sets—and what to do when interference is encountered with this type of set. Details on how to make installations in "turret-top" cars are included. The different methods used by car makers and set manufacturers are listed with the individual circuits and service information. The index contains the listing of sets which were published in the first edition, as well as the sets which appear in the new volume. This information helps the Service Man to locate the circuit and details for any receiver that has been made.

The book is bound in a handy, flexible leatherette cover. To be sure the pages are sturdy, to withstand constant use, the book is printed on a special "Bible" stock. This is a very durable, but thin paper. The book printed on this paper can be easily folded to fit into your pocket or slipped in the service kit.



240 Pages
 Over 500 Illustrations
 Size 9" x 12"

Flexible, Looseleaf Leatherette Cover

\$2.50
 LIST

MAIL COUPON TODAY FOR ANY MANUAL!

GERNSBACK PUBLICATIONS, Inc. RC-236
 99 Hudson Street, New York, N. Y.

Enclosed you will find my remittance of \$ for which please send me promptly, POSTPAID, the OFFICIAL RADIO SERVICE MANUAL indicated.

- | | |
|--|--|
| <input type="checkbox"/> 1935 Edition @ \$7.00 | AUTO-RADIO MANUALS |
| <input type="checkbox"/> 1934 Edition @ \$3.50 | <input type="checkbox"/> 1935 Edition @ \$2.50 |
| <input type="checkbox"/> 1933 Edition @ \$5.00 | <input type="checkbox"/> 1933 Edition @ \$2.50 |
| <input type="checkbox"/> 1932 Edition @ \$5.00 | |
| <input type="checkbox"/> 1931 Edition @ \$4.50 (Including Supplements) | |

Name

Address

City State

(Send remittance by check, money order, or register letter if it contains cash. Currency of unused U. S. Postage Stamps.)

99 Hudson Street

New York, N. Y.

OVERSEAS READERS!

These books can be obtained from the following houses:

GREAT BRITAIN
 Gorrings', 9a, Green Street, Leicester Square, London, England

FRANCE
 Editions Radio, 42 Rue Jacob, Paris

AUSTRALIA
 McGill's 183-195, 218 Elizabeth St., Melbourne, C. I.

Please Say That You Saw It in RADIO-CRAFT

KABLE BROS. CO., PRINTERS

only
MIDWEST

Gives You an
**18-TUBE
Radio** (for
Metal or Glass Tubes)

SIX TUNING RANGES
4½ to 2400 METERS
FULL SCOPE
HIGH FIDELITY
PUSH BUTTON TUNING
ROBOT EAR
and Scores of Other
Features for

\$59.50
with New
GIANT
THEATRE-
SONIC
SPEAKER

SAVE UP TO 50%

Direct FROM MIDWEST
LABORATORIES



**30 Days
FREE Trial!**

No middlemen's profits to pay. You buy at wholesale price, direct from Laboratories . . . saving 30% to 50%.

You can order your 1936 Midwest radio from the new 40-page catalog with as much certainty of satisfaction as if you were to come yourself to our great laboratories. You save 30% to 50% . . . you get 30 days free trial . . . as little as \$5.00 down puts a Midwest radio in your home. You are triply protected with a One-Year Guarantee, Foreign Reception Guarantee and Money-Back Guarantee.

GUARANTEED FOREIGN RECEPTION

This super radio will out-perform \$200 and \$300 sets on a side by side test. It is so powerful, so amazingly selective, so delicately sensitive that it brings in distant foreign stations with full loud speaker volume, on channels adjacent to powerful locals. The 18 tubes permit of advanced circuits, make it possible to use the tremendous reserve power, and to exert the sustained maximum output of the powerful new tubes.

80 SENSATIONAL ADVANCEMENTS

Scores of marvelous Midwest features, many of them exclusive, explain Midwest glorious tone realism, super performance and thrilling world-wide 6-band reception. They prove why nationally known orchestra leaders like Fred Waring, George Olsen, Jack Denny, etc., use a Midwest in preference to more costly makes. Pages 12 to 21 in FREE catalog illustrate the new Midwest features. Study them before you make up your mind.

ACOUSTI-TONE V-SPREAD DESIGN

The V-Front Dispersing Vanes established a new radio style overnight. They spread the beautiful lace-work of the "highs" throughout the room in a scientific manner . . . directing the High Fidelity waves uniformly to the ear. Now, get complete range of audible frequencies from 30 to 16,000 cycles . . . achieving glorious new acousti-tone . . . assuring life-like crystal-clear reception . . . "concert" realism.

SIX TUNING RANGES

This exclusive engineering triumph (U. S. Patent No. 96750) puts Midwest radio years ahead of ordinary sets and makes them the "World's Greatest Radio Values." Now, it is easy to make the nations of the world parade before you. You can switch instantly from American programs to Canadian, police, amateur, commercial, "secret," experimental, airplane and ship broadcasts . . . to the finest and most fascinating programs from Europe, Asia, Australia, South America . . . 12,000 miles away.



Send for FREE 40-page four-color catalog. It pictures the complete line of beautiful 1936 Midwest Acousti-Tone V-Spread consoles . . . and chassis . . . in actual colors.



Push Button Tuning

Simply pushing Silencer Button silences set between stations. Beautiful tuning lights automatically indicate when station is properly tuned. Release button . . . and station comes in perfectly. Pressing Station Finder Button (Midwest's exclusive ROBOT EAR) automatically determines proper dial position for bringing in extremely weak stations.

Ted Weems Enthuses Over Crystal-Clear World Reception

Dearborn, Mich.—After comparing many radios, I can truthfully say my Midwest out-performs other sets costing almost twice as much. Only the new Midwest could satisfy my desire for crystal-clear, undistorted reception . . . from all over the world.



Ted Weems.

TERMS AS LOW AS \$5.00 DOWN

ONCE again Midwest demonstrates its leadership by offering the world's most powerful Super De Luxe 18-METAL Tube 6-Tuning Range radio. It is a master achievement . . . today's most highly perfected, precisely built, laboratory adjusted set. It is a radio musical instrument that will thrill you with its marvelous super performance . . . glorious new acousti-tone . . . crystal-clear "concert" realism . . . and magnificent foreign reception. Before you buy any radio, write for FREE 40-page 1936 catalog. Learn about the successful Midwest Laboratory-To-You policy that saves you 30% to 50% . . . that gives you 30 days FREE trial.

MAIL COUPON TODAY for

**Free 30-DAY TRIAL OFFER
and 40-PAGE FOUR-COLOR Free CATALOG**

MIDWEST RADIO CORPORATION
Dept. 12H, Cincinnati, Ohio

Without obligation on my part, send me your new FREE catalog, complete details of your liberal 30-day FREE trial offer, and FREE Miniature Rotating 18-tube Dial. This is NOT an order.

User - Agents
Make Easy
Extra Money
Check Here
for
details

Name

Address

Town..... State

Check If interested in a Midwest All-Wave Battery Radio

MIDWEST RADIO CORP.

DEPT. 12H CINCINNATI, OHIO U.S.A.

Established 1920

Cable Address MIRACO All Codes

SHORT-WAVE RECEPTION

IS POSITIVELY BETTER WITH

G-E's NEW V-DOUBLET ANTENNA

● Every owner of an all-wave receiver wants his set to perform at maximum efficiency. He wants uniformly good reception — a minimum of noise. All this depends to a large degree on the type of antenna system used.

The new G-E V-Doublet All-wave Antenna System approaches the ideal more closely than any heretofore available.

Notice the unique "V" construction. The "V" provides an efficient transfer of energy from the antenna to the lead-in (transmission line). A special transformer, in turn, provides an efficient transfer of energy from the lead-in to the receiver and at the same time balances out interference picked up by the lead-in.

Below 55 meters, the antenna operates as a V-Doublet and above 55 meters, it is automatically changed to a standard antenna by the special coupling transformer. Therefore man-made interference is minimized, giving clear short-wave reception and, without switching, excellent reception of standard broadcasts as well.

Simple to install—requires only 2 points of suspension over a 50-foot span. Not unsightly in appearance when installed. Any length lead-in of 100 feet or over may be used. This new exclusively General Electric Antenna System is exactly what every all-wave radio owner has been wanting. Mail the coupon for complete details.

Price of antenna kit \$5.95.

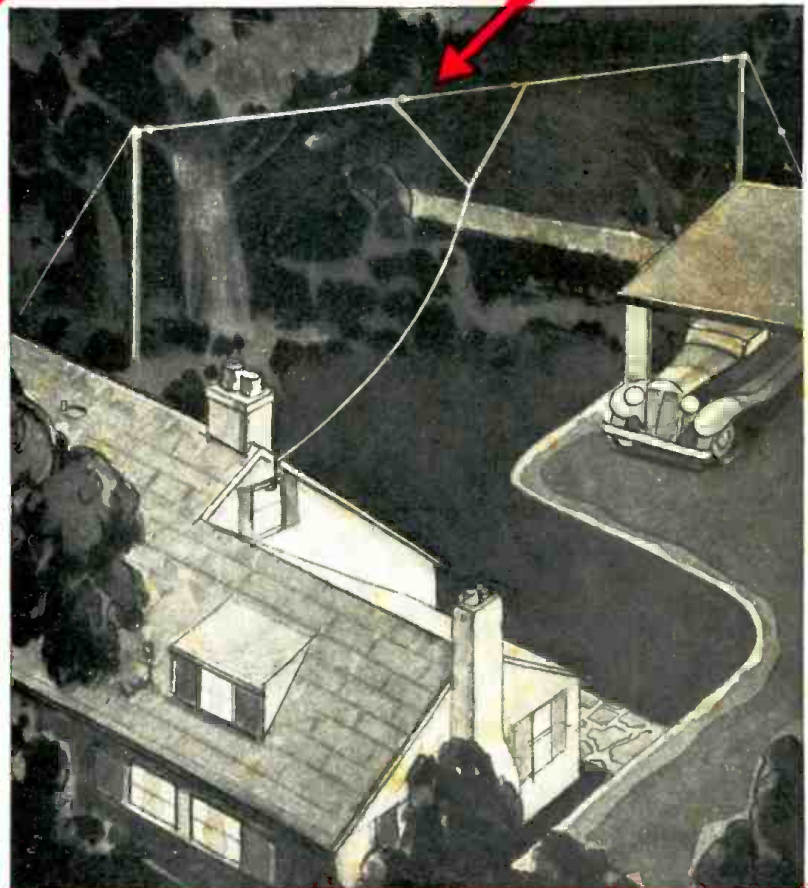

General Electric Company,
Merchandise Department,
Bridgeport, Conn.

Attention: Sales Promotion Section

I am interested in the New G-E All-wave Antenna System. Without obligation on my part, I would like to have you send me details regarding it.

Name.....

Street address.....

City.....State.....

GENERAL ELECTRIC

The Original Metal-tube Radio

MERCHANDISE DEPARTMENT, GENERAL ELECTRIC COMPANY, BRIDGEPORT, CONNECTICUT